



EUROPEAN COMMISSION
EUROSTAT



Unit G4

International Transactions

GEONOMENCLATURE



2010

EN

CONTENTS

	Page
Introduction	5
Changes 2007.....	9
Changes 2008.....	12
Changes 2009.....	13
Changes 2010	14
Maps	15
Geonomenclature 2007 -	29
Economic zones 2010	51
Geographical zones 2010	61
Development of the codes since 1976	67
Correspondence codes-zones.....	79
Correspondence ISO 3166 codes-EU codes.....	93
Alphabetical index	101

INTRODUCTION

The nomenclature of countries and territories for the international trade in goods statistics of the Community - known as the "geonomenclature", abbreviated to GEONOM - is an essential element in compiling these statistics. In particular, it makes it possible to identify those involved in trade, i.e. the reporting country and the partner country.

The creation, maintenance and use of this nomenclature are laid down by Article 9 of Council Regulation (EC) No 1172/95 of 22.5.1995 (OJ L 118 of 25.5.1995) on the statistics relating to the trading of goods by the Community and its Member States with non-member countries. As for the statistics on intra-Community trade, Article 7 of Regulation (EC) No 1982/2004 of 18.11.2004 also refers to this nomenclature.

When necessary the geonomenclature is subject to revision in order to incorporate the adjustments needed for statistical purposes and to take into account any geopolitical change that may have occurred. Commission Regulation (EC) No 1833/2006 of 13.12.2006, which lays down the geonomenclature **applicable as from 1.1.2007**, was published in OJ L 354 of 14.12.2006.

The Regulation requires those responsible for supplying statistical information to stop using numerical codes, but to help Comext users they are still included in this publication.

The purpose of this publication is to provide users with all the supplementary information on the GEONOM 2010 that is essential to understand its content and to illustrate the changes in country codes in order to facilitate analysis of the results of the statistics on the European Union's international trade in goods.

With a view to improving the next edition and providing a better response to users' needs, any corrections or comments are welcome.



CHANGES

Geonomenclature

Creations	Deletions	Modifications
ME (097) Montenegro	XM (097) Montenegro	

Economic zones

Zones	2007
1010 European Union (evolutionary)	+ BG (068) Bulgaria + RO (066) Romania
1013 Euro-zone since 1999 (evolutionary)	+ SI (091) Slovenia
1014 Extra-euro zone since 1999 (evolutionary)	- 1811 Extra-European Union (15) + 1814 Extra-European Union (27) + BG (068) Bulgaria + CY (600) Cyprus + CZ (061) Czech Republic + EE (053) Estonia + HU (064) Hungary + LT (055) Lithuania + LV (054) Latvia + MT (064) Malta + PL (060) Poland + RO (066) Romania + SK (063) Slovakia
1031 ACP African, Caribbean and Pacific countries	Modified title
1053 OPEC Organisation of Petroleum Exporting Countries	+ AO (330) Angola
1059 SAARC South Asian Association for Regional Cooperation	+ AF (660) Afghanistan ¹
1112 European Union (27)	1111 European Union (25) + BG (068) Bulgaria + RO (066) Romania
1114 Euro-zone (13)	1113 Euro-zone (12) + SI (091) Slovenia

1120 WBCs Western Balkan Countries	Modified title - BG (068) Bulgaria - RO (066) Romania - XM (097) Montenegro + ME (097) Montenegro
1130 Candidate countries	- BG (068) Bulgaria - RO (066) Romania + MK (096) Former Yugoslav Republic of Macedonia ²
1430 LDC Least Developed Countries	+ TL (626) Timor-Leste ³
1812 Extra-european Union (25)	- XM (097) Montenegro + ME (097) Montenegro
1814 Extra-european Union (27)	1812 Extra-european Union (25) - BG (068) Bulgaria - RO (066) Romania - XM (097) Montenegro + ME (097) Montenegro
1816 Extra-euro zone (13)	1814 Extra-European Union (27) + BG (068) Bulgaria + CY (600) Cyprus + CZ (061) Czech Republic + DK (008) Denmark + EE (053) Estonia + GB (006) United Kingdom + HU (064) Hungary + LT (055) Lithuania + LV (054) Latvia + MT (046) Malta + PL (060) Poland + RO (066) Romania + SE (030) Sweden + SK (063) Slovakia

Geographical zones

Zones	2007
5000 World	- 5900 Miscellaneous – countries not specified and countries not determined + 5920 Miscellaneous – countries not specified extra + 5990 Miscellaneous – countries not determined
5110 European Union	+ BG (068) Bulgaria + RO (066) Romania
5190 Other European countries	- BG (068) Bulgaria - RO (066) Romania - XM (097) Montenegro + ME (097) Montenegro

¹ From 1.11.2005

² From 1.1.2006

³ From 1.1.2004

- = Deletions

+ = Creations

Economic zones

Zones	2008
1013 Euro-zone since 1999 (evolutionary)	+ CY (600) Cyprus + MT (046) Malta
1014 Extra-euro zone since 1999 (evolutionary)	- CY (600) Cyprus - MT (046) Malta
1053 OPEC Organisation of Petroleum Exporting Countries	+ EC (500) Ecuador
1116 Euro-zone (15)	1114 Euro-zone (13) + CY (600) Cyprus + MT (046) Malta
1430 LDC Least Developed Countries	- CV (247) Cape Verde
1817 Extra-euro-zone (15)	1814 Extra-European Union (27) + BG (068) Bulgaria + CZ (061) Czech Republic + DK (008) Denmark + EE (053) Estonia + GB (006) United Kingdom + HU (064) Hungary + LT (055) Lithuania + LV (054) Latvia + PL (060) Poland + RO (066) Romania + SE (030) Sweden + SK (063) Slovakia
1820 OECD (excluding EU) Organisation for Economic Cooperation and Development, excluding EU	- LI (037) Liechtenstein ¹

¹ Introduced by error on 1.1.2005

Economic zones

Zones	2009
1013 Euro-zone since 1999 (evolutionary)	+ SK (063) Slovakia
1014 Extra-euro zone since 1999 (evolutionary)	- SK (063) Slovakia
1053 OPEC Organisation of Petroleum Exporting Countries	- ID (700) Indonesia
1117 Euro-zone (16)	1116 Euro-zone (15) + SK (063) Slovakia
1118 Extra-euro zone (16)	1817 Extra-euro zone (15) - SK (063) Slovakia

Economic zones

Zones	2010
1055 MEDA Union for the Mediterranean (excluding EU)	+ AL (070) Albania + BA (093) Bosnia and Herzegovina + HR (092) Croatia + ME (097) Montenegro + MR (228) Mauritania
1815 CIS Commonwealth of Independent States	- GE (076) Georgia



MAPS

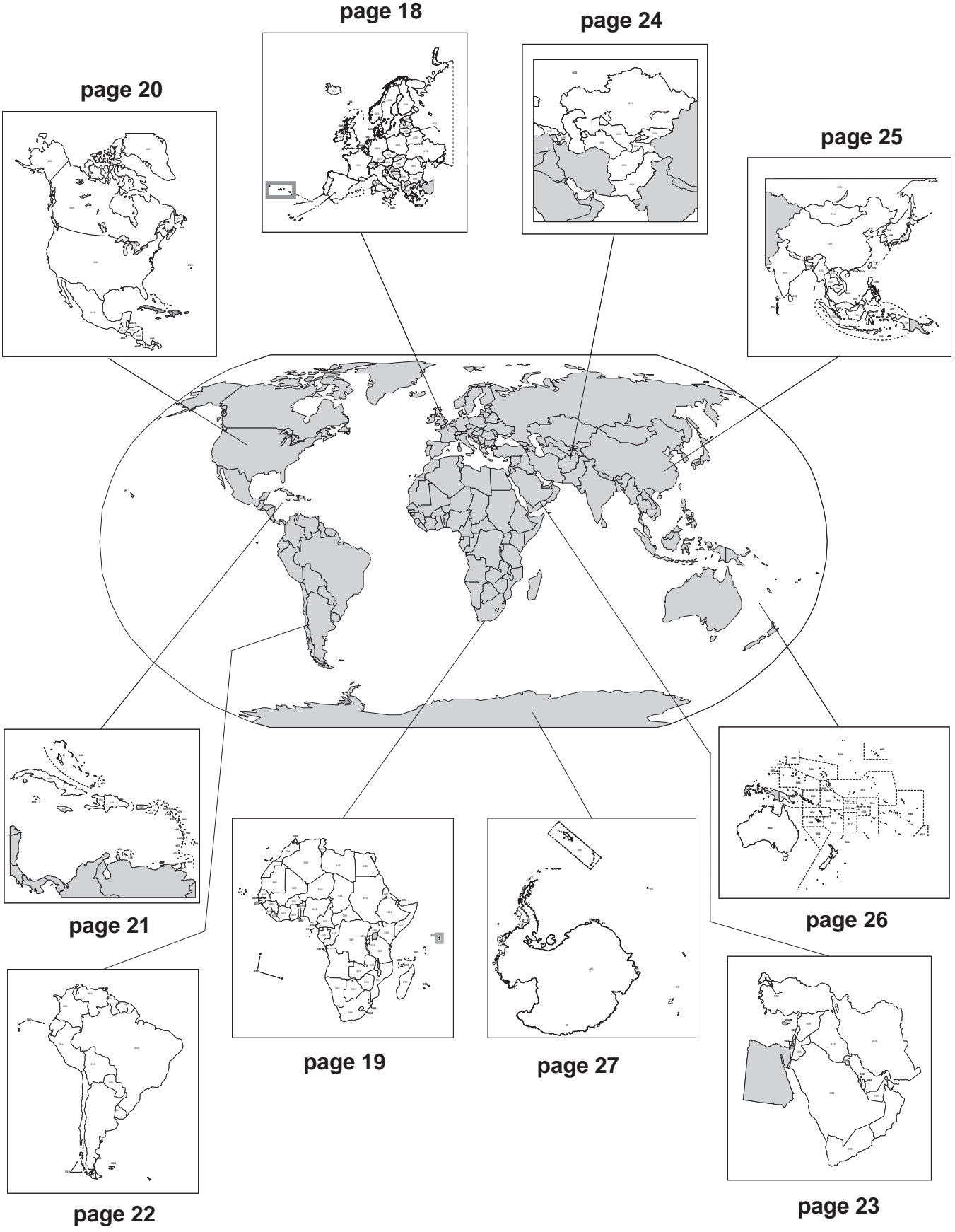

Europe

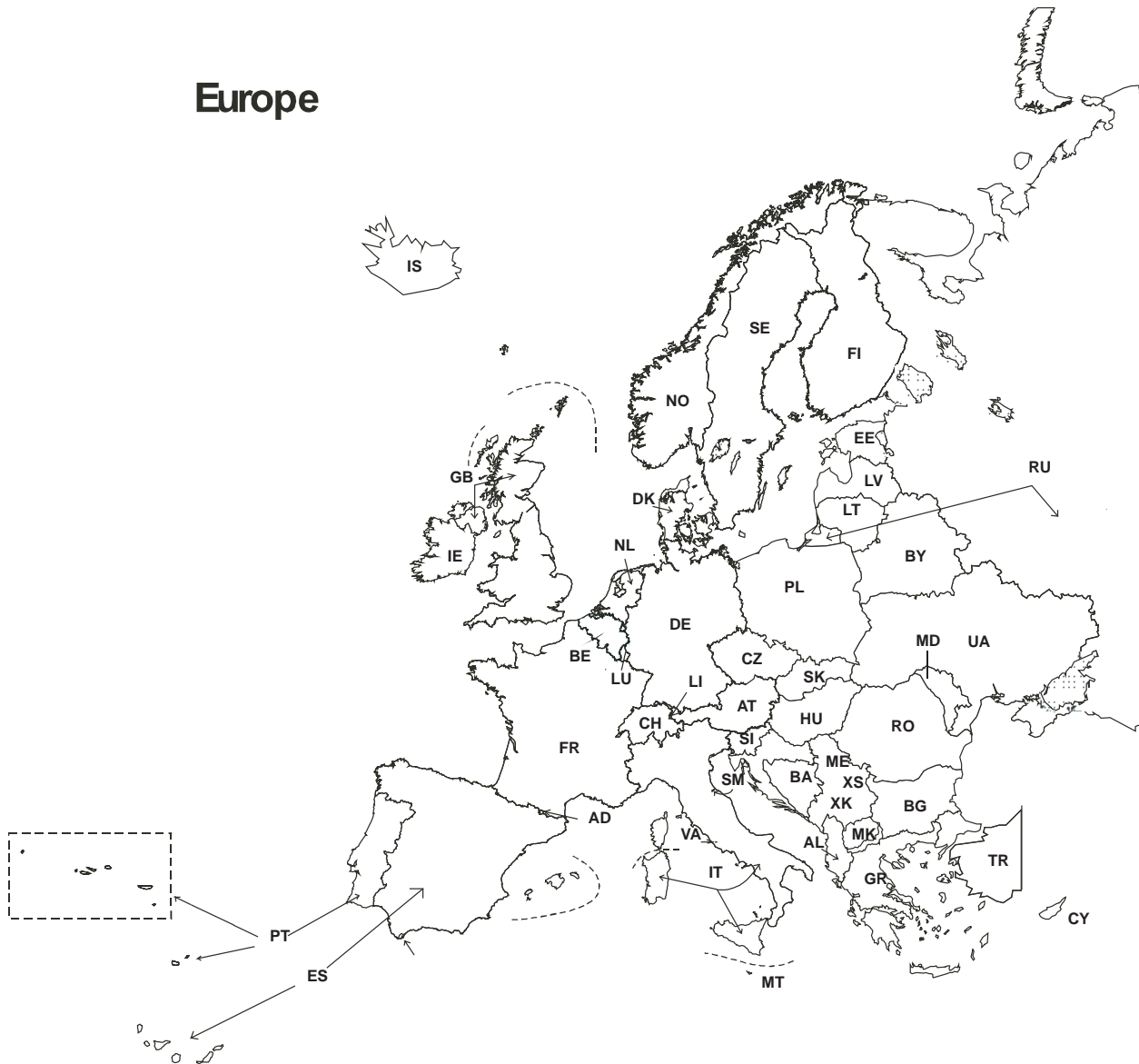

AD (043)	Andorra	IT (005)	Italy
AL (070)	Albania	LI (037)	Liechtenstein
AT (038)	Austria	LT (055)	Lithuania
BA (093)	Bosnia and Herzegovina	LU (018)	Luxembourg
BE (017)	Belgium	LV (054)	Latvia
BG (068)	Bulgaria	MD (074)	Moldova (Republic of)
BY (073)	Belarus	ME (097)	Montenegro
CH (039)	Switzerland	MK (096)	Former Yugoslav Republic of Macedonia
CY (600)	Cyprus	MT (046)	Malta
CZ (061)	Czech Republic	NL (003)	Netherlands
DE (004)	Germany	NO (028)	Norway
DK (008)	Denmark	PL (060)	Poland
EE (053)	Estonia	PT (010)	Portugal
ES (011)	Spain	RO (066)	Romania
FI (032)	Finland	RU (075)	Russian Federation
FO (041)	Faroe Islands	SE (030)	Sweden
FR (001)	France	SI (091)	Slovenia
GB (006)	United Kingdom	SK (063)	Slovakia
GI (044)	Gibraltar	SM (047)	San Marino
GR (009)	Greece	TR (052)	Turkey
HR (092)	Croatia	UA (072)	Ukraine
HU (064)	Hungary	VA (045)	Holy See (Vatican City State)
IE (007)	Ireland	XK (095)	Kosovo
IS (024)	Iceland	XS (098)	Serbia

Afrique

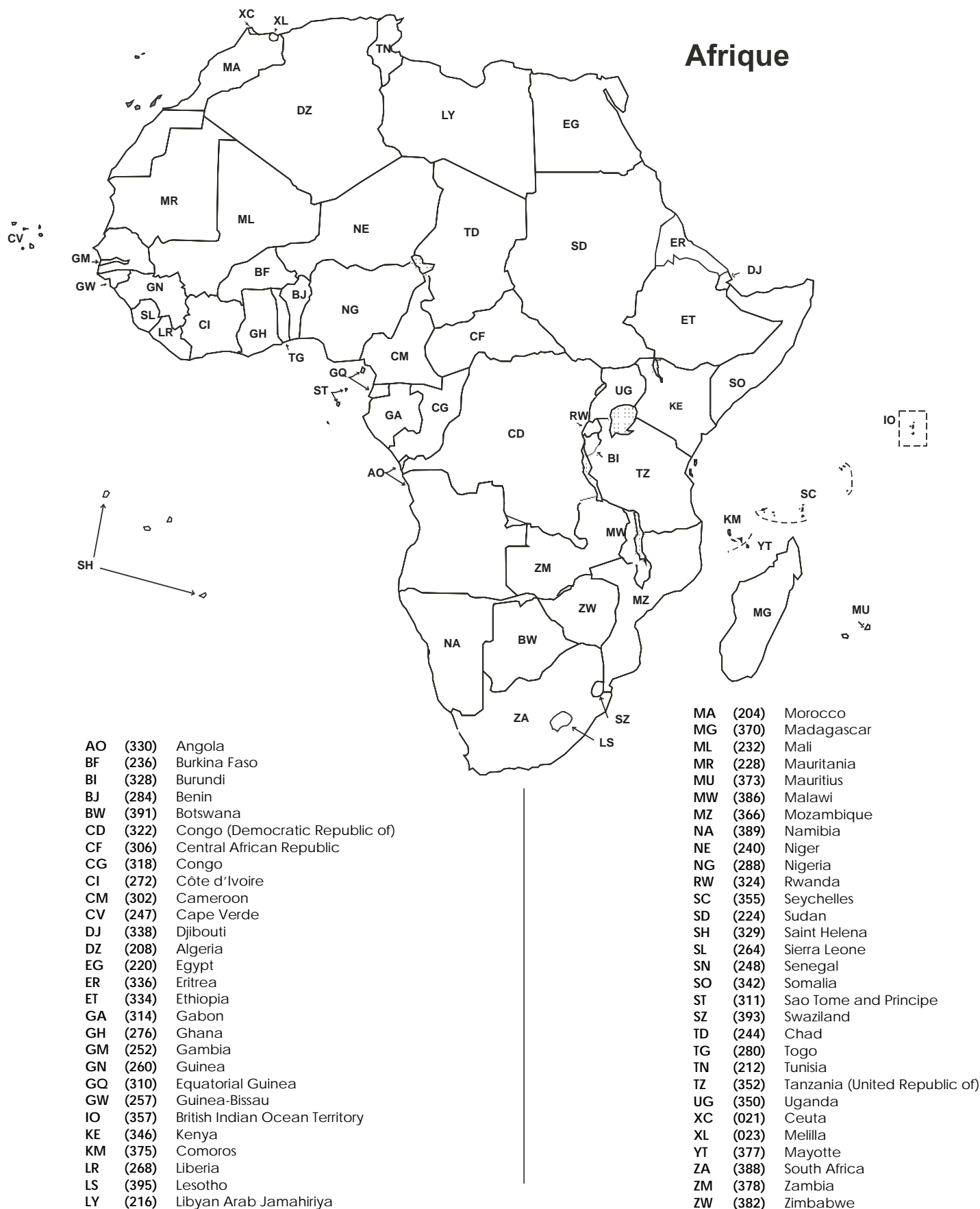

Amérique du Nord et centrale



BM	(413)	Bermuda
BZ	(421)	Belize
CA	(404)	Canada
CR	(436)	Costa Rica
GL	(406)	Greenland
GT	(416)	Guatemala
HN	(424)	Honduras
MX	(412)	Mexico
NI	(432)	Nicaragua
PA	(442)	Panama
PM	(408)	St Pierre and Miquelon
SV	(428)	El Salvador
US	(400)	United States

Antilles et Îles Bahamas

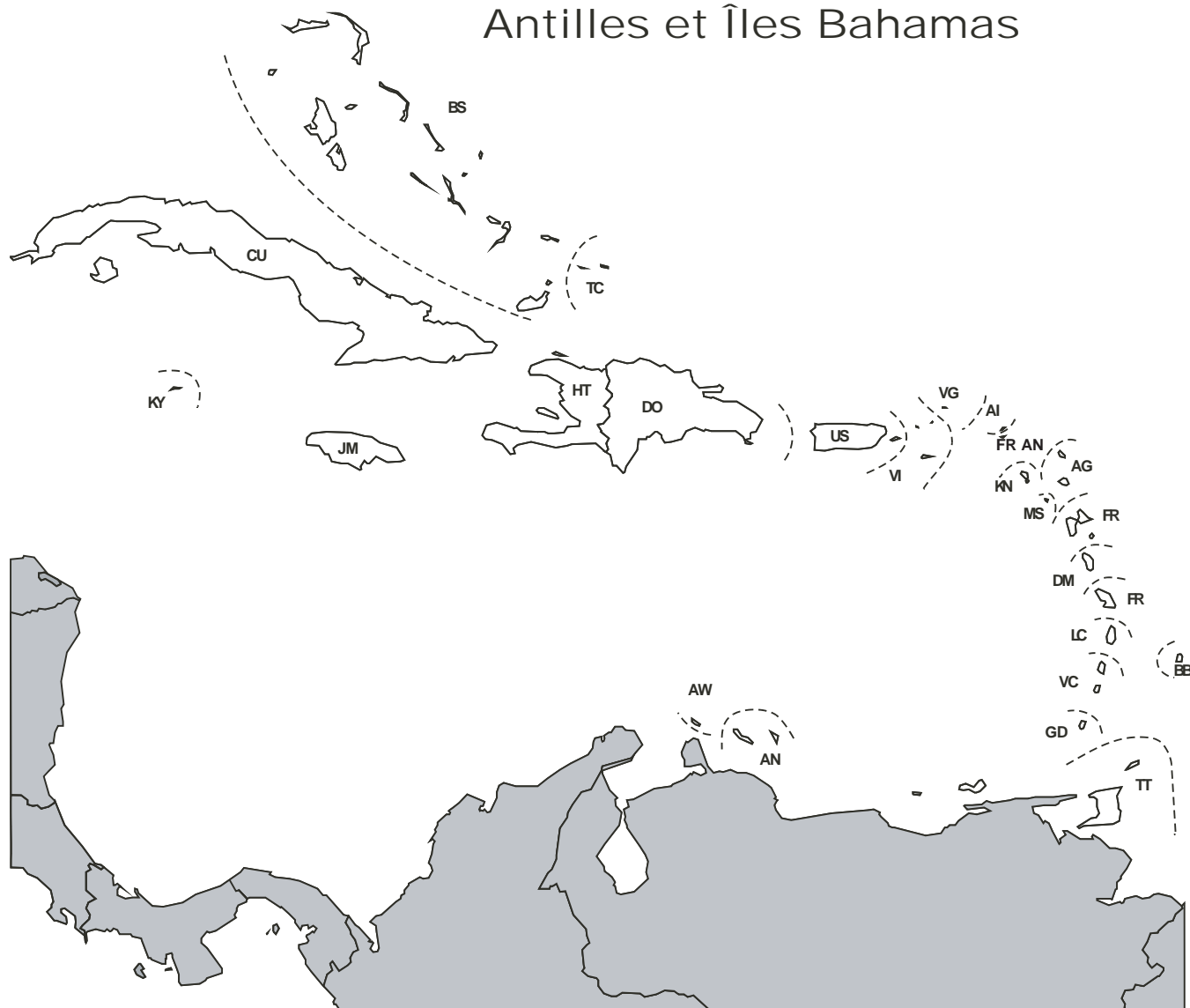

AG	(459)	Antigua and Barbuda
AI	(446)	Anguilla
AN	(478)	Netherlands Antilles
AW	(474)	Aruba
BB	(469)	Barbados
BS	(453)	Bahamas
CU	(448)	Cuba
DM	(460)	Dominica
DO	(456)	Dominican Republic
FR	(001)	Martinique, Guadeloupe and Sint-Maarten (France)
GD	(473)	Grenada
HT	(452)	Haiti

JM	(464)	Jamaica
KN	(449)	St Kitts and Nevis
KY	(463)	Cayman Islands
LC	(465)	St Lucia
MS	(470)	Montserrat
TC	(454)	Turks and Caicos Islands
TT	(472)	Trinidad and Tobago
US	(400)	Puerto Rico (United States)
VC	(467)	St Vincent and Grenadines
VG	(468)	Virgin Islands (British)
VI	(457)	Virgin Islands (US)

Amérique du Sud



AR	(528)	Argentina
BO	(516)	Bolivia
BR	(508)	Brazil
CL	(512)	Chile
CO	(480)	Colombia
EC	(500)	Ecuador
FK	(529)	Falkland Islands

FR	(001)	French Guiana (France)
GY	(488)	Guyana
PE	(504)	Peru
PY	(520)	Paraguay
SR	(492)	Suriname
UY	(524)	Uruguay
VE	(484)	Venezuela

Moyen-Orient



AE	(647)	United Arab Emirates
BH	(640)	Bahrain
IL	(624)	Israel
IQ	(612)	Iraq
IR	(616)	Iran (Islamic Republic of)
JO	(628)	Jordan
KW	(636)	Kowait
LB	(604)	Lebanon

OM	(649)	Oman
PS	(625)	Occupied Palestinian Territory
QA	(644)	Qatar
SA	(632)	Saudi Arabia
SY	(608)	Syrian Arab Republic
TR	(052)	Turkey
YE	(653)	Yemen

Asie occidentale



AF (660) Afghanistan
AM (077) Armenia
AZ (078) Azerbaijan
GE (076) Georgia
KG (083) Kyrgyzstan
KZ (079) Kazakhstan

PK (662) Pakistan
RU (075) Russian Federation
TJ (082) Tajikistan
TM (080) Turkmenistan
UZ (081) Uzbekistan

Asie orientale

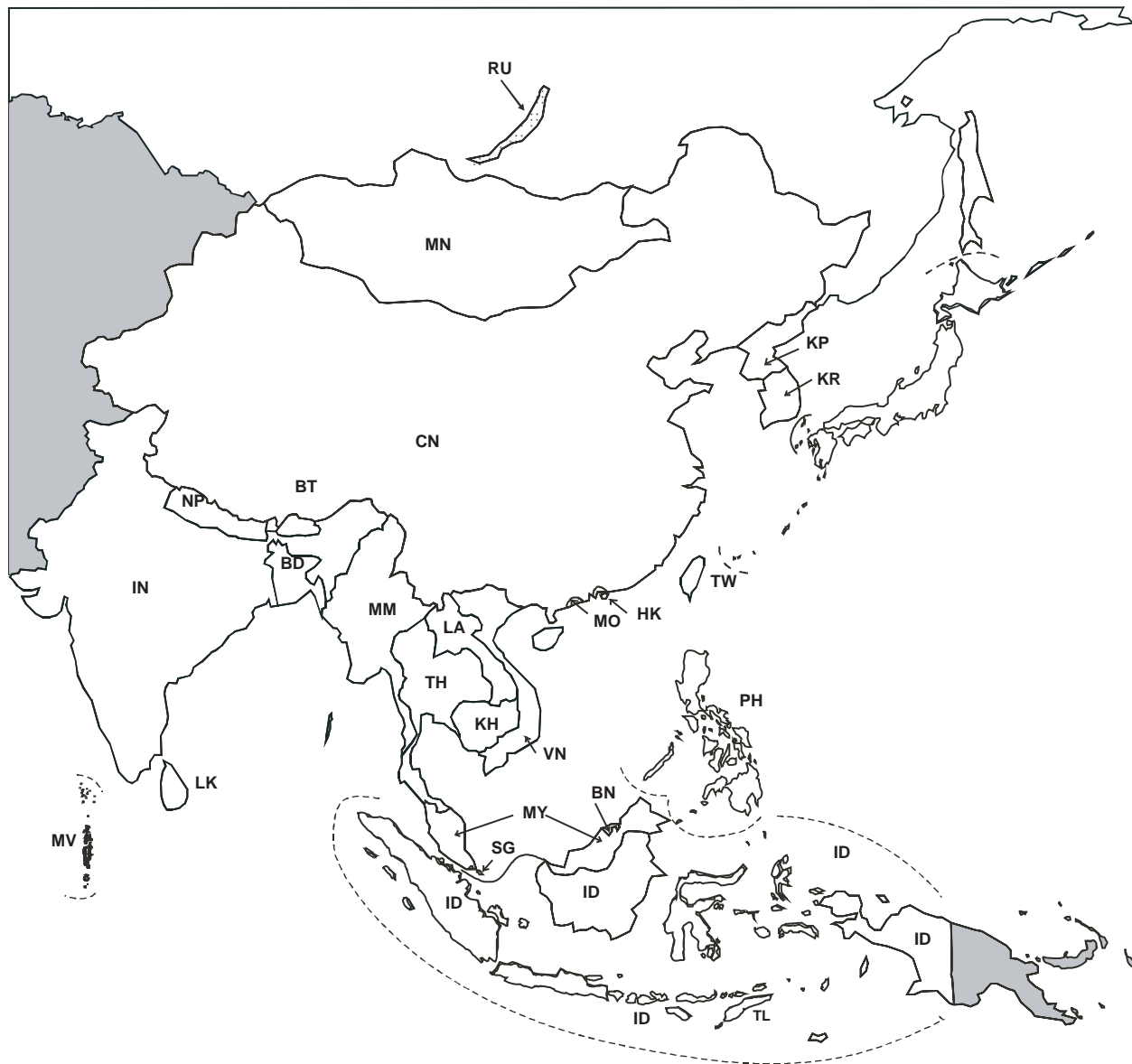

BD	(666)	Bangladesh
BN	(703)	Brunei Darussalam
BT	(675)	Bhutan
CN	(720)	China
HK	(740)	Hong Kong
ID	(700)	Indonesia
IN	(664)	India
JP	(732)	Japan
KH	(696)	Cambodia
KP	(724)	Korea, Democratic People's Republic of
KR	(728)	Korea, Republic of
LA	(684)	Lao People's Democratic Republic
LK	(669)	Sri Lanka

MM	(676)	Myanmar
MN	(716)	Mongolia
MO	(743)	Macao
MV	(667)	Maldives
MY	(701)	Malaysia
NP	(672)	Nepal
PH	(708)	Philippines
RU	(075)	Russian Federation
SG	(706)	Singapore
TH	(680)	Thailand
TL	(626)	Timor-Leste
TW	(736)	Taiwan
VN	(690)	Viet-Nam

Océanie



AS	(830)	American Samoa
AU	(800)	Australia
CC	(833)	Cocos Islands (or Keeling Islands)
CK	(837)	Cook Islands
CX	(834)	Christmas Islands
FJ	(815)	Fiji
FM	(823)	Micronesia (Federated States of)
GU	(831)	Guam
HM	(835)	Heard Island and McDonald Islands
KI	(812)	Kiribati
MH	(824)	Marshall Islands
MP	(820)	Northern Mariana Islands
NC	(809)	New Caledonia
NF	(836)	Norfolk Island
NR	(803)	Nauru

NU	(838)	Niue
NZ	(804)	New Zealand
PF	(822)	French Polynesia
PG	(801)	Papua New Guinea
PN	(813)	Pitcairn
PW	(825)	Palau
SB	(806)	Salomon Islands
TK	(839)	Tokelau
TO	(817)	Tonga
TV	(807)	Tuvalu
UM	(832)	United States Minor Outlying Islands
US	(400)	The Hawaiian Islands (United States)
VU	(816)	Vanuatu
WF	(811)	Wallis and Futuna
WS	(819)	Samoa

Antarctique (Pôle Sud)

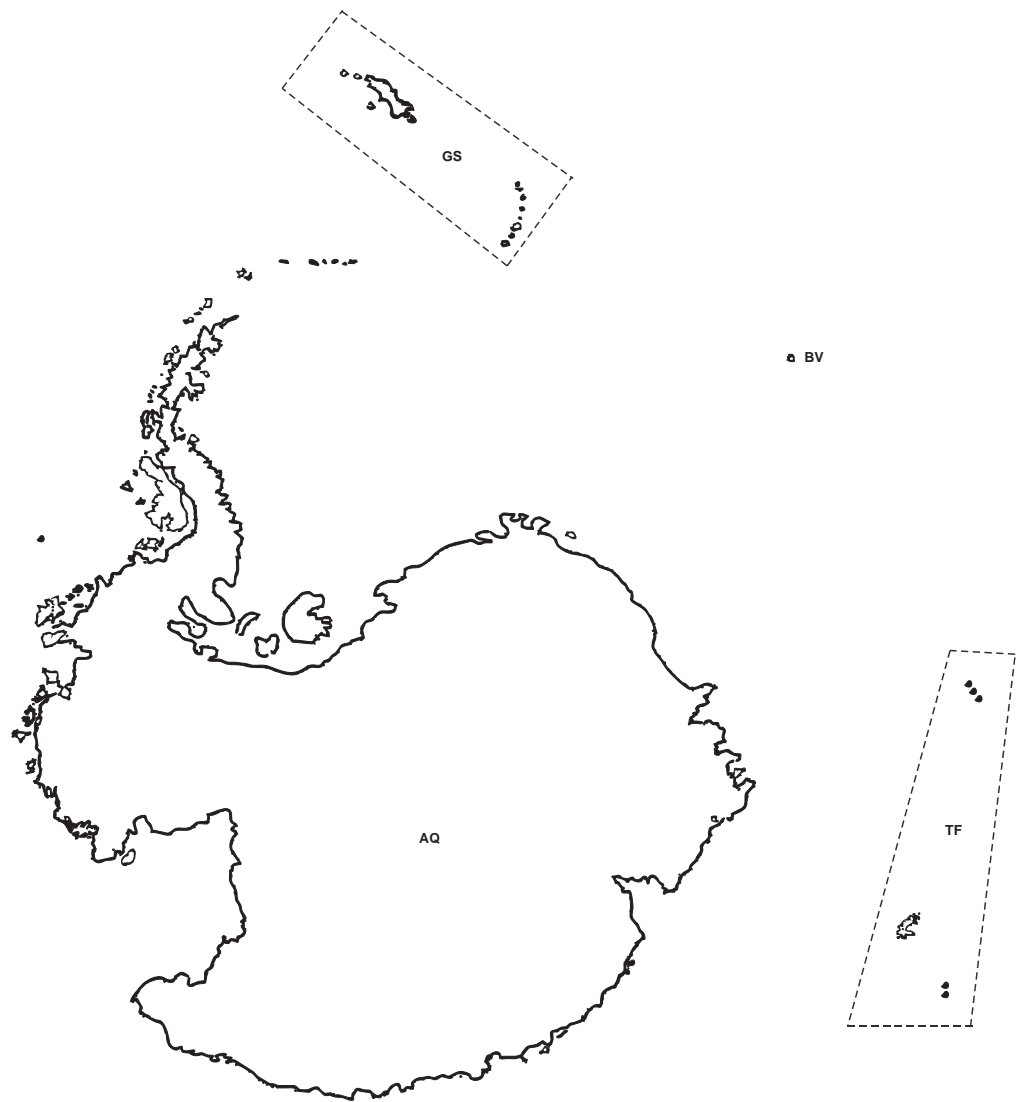

- AQ (891) Antarctica
- BV (892) Bouvet Island
- GS (893) South Georgia and South Sandwich Islands
- TF (894) French Southern Territories



GEONOMENCLATURE

Code		Text	Description	Observations
ISO	GEO			
1	2	3	4	5
AD	(043)	Andorra		
AE	(647)	United Arab Emirates	Abu Dhabi, Ajman, Dubai, Fujairah, Ras al Khaimah, Sharjah and Umm al Qaiwain	
AF	(660)	Afghanistan		
AG	(459)	Antigua and Barbuda		Including Redonda Island.
AI	(446)	Anguilla		Including Sombrero Island. See code GB (006).
AL	(070)	Albania		
AM	(077)	Armenia		Until 30 June 1992 Armenia appeared under code SU (056) USSR.
AN	(478)	Netherlands Antilles	Bonaire, Curaçao, Saba, St Eustatius and southern part of St Martin	Bonaire and Curaçao are part of the Leeward Islands. Sint Maarten, Saba and Sint Eustatius are part of the Windward Islands. They comprise an autonomous state linked to the Netherlands since 1954, but dissolved as from 10/10/2010. However, code AN maintained for the timebeing. See code NL (003).
AO	(330)	Angola	Including Cabinda	The enclave of Cabinda is bordered by Congo, Congo (Dem. Rep.) and the Atlantic Ocean.
AQ	(891)	Antarctica	Territory south of 60° south latitude; not including the French Southern Territories (TF), Bouvet Island (BV), South Georgia and South Sandwich Islands (GS)	Including Adelie Land, Australian Antarctic Territory, Peter 1st Island, Queen Maud Land, Ross Dependency and British Antarctic Territory including South Orkney Islands, South Shetland Islands and the Antarctic Peninsula.
AR	(528)	Argentina		Including the territory of Tierra del Fuego (the eastern part of Tierra del Fuego island and several small islands, including Staten Island).
AS	(830)	American Samoa		American Samoa Archipelago comprises seven islands : Ta'u, Olosega, Ofu, Aunu'u, Rose, Swains and Tutuila. See code US (400).

Code		Text	Description	Observations
ISO	GEO			
1	2	3	4	5
AT	(038)	Austria		
AU	(800)	Australia		The following territories, although under australian administration, appear under the following codes: <ul style="list-style-type: none"> •CC (833) - Cocos (Keeling), Islands •CX (834) - Christmas Island •HM (835) - Heard Island and McDonald Islands •NF (836) - Norfolk Island
AW	(474)	Aruba		Located in the Lesser Antilles, with semi-autonomous status since 1986. See code NL (003).
AZ	(078)	Azerbaijan		Until 30 June 1992 Azerbaijan appeared under code SU (056) USSR. Azerbaijan also includes the Nagorno-Karabakh Autonomous Province and the Nakhichevan Autonomous Republic.
BA	(093)	Bosnia and Herzegovina		Until 30 June 1992 Bosnia and Herzegovina appeared under code YU (048) Yugoslavia. See code SI (091).
BB	(469)	Barbados		
BD	(666)	Bangladesh		
BE	(017)	Belgium		
BF	(236)	Burkina Faso		Formerly Upper Volta until 1984.
BG	(068)	Bulgaria		
BH	(640)	Bahrain		Consists of 33 islands, the most important of which are Bahrain, Mouharraq and Sitrah.
BI	(328)	Burundi		
BJ	(284)	Benin		
BM	(413)	Bermuda		The major islands are Great Bermuda (or Main Island), Somerset, Ireland, St George, St David and Boaz. See code GB (006).
BN	(703)	Brunei Darussalam	Often referred to as Brunei	Officially called Negara Brunei Darussalam. Located on the island of Borneo.
BO	(516)	Bolivia		

Code		Text	Description	Observations
ISO	GEO			
1	2	3	4	5
BR	(508)	Brazil		Including Fernando de Noronha Island, Martim Vez Islands, Trindade Island.
BS	(453)	Bahamas		The archipelago includes primarily Bimini, New Providence, Andros, Eleuthera, Grand Bahama, Great Abaco, Great Inagua, Harbour, Long, Mayaguana and San Salvador islands.
BT	(675)	Bhutan		
BV	(892)	Bouvet Island		Formerly code XR (890) until 2000 Polar regions See code NO (028).
BW	(391)	Botswana		
BY	(073)	Belarus	Often referred to as Belorussia	Until 30 June 1992 Belarus appeared under code SU (056) USSR.
BZ	(421)	Belize		Includes Ambergris Cay and Turneffe Islands.
CA	(404)	Canada		Including the Canadian Arctic Archipelago, of which the main islands are: Bank Island, Devon Island, Ellesmere Island, Parry Islands, Sverdrup Islands and Victoria Island.
CC	(833)	Cocos (Keeling), Islands		Formerly code XO (802) until 2000 Australian Oceania. See code AU (800).
CD	(322)	Congo, Democratic Republic of	Formerly Zaire	
CF	(306)	Central African Republic		
CG	(318)	Congo		
CH	(039)	Switzerland	Including the German territory of Büsingen and the Italian municipality of Campione d'Italia	
CI	(272)	Côte d'Ivoire	Often referred to as Ivory Coast	Officially called Côte d'Ivoire.

Code		Text	Description	Observations
ISO	GEO			
1	2	3	4	5
CK	(837)	Cook Islands		Formerly code XZ (814) until 2000 New Zealand Oceania. Main Island : Rarotonga. See code NZ (804).
CL	(512)	Chile		Also includes Chiloé Island, the Chonos archipelago, Wellington Island, the western part of Tierra del Fuego, the Juan Fernández Islands, Easter Island, Sala y Gómez Island, San Ambrosio Island and San Félix Island.
CM	(302)	Cameroon		
CN	(720)	China		Including the island of Hainan. Hong Kong is a special administrative region of China since 1977, appearing under code HK (740).
CO	(480)	Colombia		Including Malpelo Island, San Andrés and Providencia Islands.
CR	(436)	Costa Rica		Including Coco Island.
CU	(448)	Cuba		Cuba consists of the main island (Cuba), the Camagüey, Sabana, Los Jardines de la Reina, Los Canarreosa and Los Colorados archipelagos and Juventud (formerly Pinos) Island.
CV	(247)	Cape Verde		The archipelago comprises the islands of Santo Antão, São Vicente, Santa Luzia, Branco, Raso, São Nicolau, Sal, Boa Vista, Santiago, Brava, Fogo, Rombo and Maio.
CX	(834)	Christmas Island		Formerly code XO (802) until 2000 Australian Oceania. See code AU (800).
CY	(600)	Cyprus		
CZ	(061)	Czech Republic		The Czech Republic and Slovakia formed Czechoslovakia until 1992.
DE	(004)	Germany	Including the island of Heligoland; excluding the territory of Büsingen	The territory of Büsingen is attached to Switzerland. See code CH (039).
DJ	(338)	Djibouti		

Code		Text	Description	Observations
ISO	GEO			
1	2	3	4	5
DK	(008)	Denmark		<p>The main islands are Zealand, Funen, Lolland, Falster, Langeland, Møn and Bornholm.</p> <p>Two territories are located in the North Atlantic: the Faroe Islands appearing under code FO (041) and Greenland under code GL (406); they are thus not included in the statistical territory of Denmark.</p>
DM	(460)	Dominica		
DO	(456)	Dominican Republic		Consists of the eastern part of the island of Hispaniola and Saona Island.
DZ	(208)	Algeria		
EC	(500)	Ecuador	Including the Galápagos Islands	The Galapagos Island principally includes San Cristobal Island and Isabela Island.
EE	(053)	Estonia		<p>Baltic republic, independent since 1991.</p> <p>The islands of Saaremaa and Hiiumaa are part of the territory of Estonia.</p>
EG	(220)	Egypt		
ER	(336)	Eritrea		Includes the Dahlak archipelago.
ES	(011)	Spain	Including the Balearic Islands and the Canary Islands; excluding Ceuta and Melilla	<p>The main islands comprising the Balearic Islands (located in the Mediterranean) are Majorca, Minorca, Ibiza and Formentera.</p> <p>The Canary Islands (archipelago located in the Atlantic Ocean northwest of Western Sahara) comprise Tenerife, Fuerteventura, Gran Canaria, Lanzarote, La Palma, Gomera and Hierro and have been part of the statistical territory of Spain since 1997.</p> <p>XC (021) Ceuta and XL (023) Melilla (enclaves located in northwest Africa) are thus not included in the statistical territory of Spain.</p>
ET	(334)	Ethiopia		

Code		Text	Description	Observations
ISO	GEO			
1	2	3	4	5
EU	(999)	European Community	Code reserved, in trade with non-member countries, for the declaration of the origin of goods according to the conditions laid down in the relevant Community provisions. Code not to be used for statistical purposes.	
FI	(032)	Finland	Including the Åland Islands	The Åland Islands are also known as Ahvenanmaa.
FJ	(815)	Fiji		Viti Levu and Vanua Levu are the main islands; including Rotuma Island.
FK	(529)	Falkland Islands (Malvinas)		Consisting primarily of West and East Falkland. See code GB (006).
FM	(823)	Micronesia, Federated States of	Chuuk, Kosrae, Pohnpei and Yap.	Chuuk (formerly Truk). Also includes Caroline Islands, excluding Palau Islands, see code PW (825). Independent since 1991. See code US (400).
FO	(041)	Faroe Islands		See code DK (008).
FR	(001)	France	Including Monaco and the French overseas departments (French Guiana, Guadeloupe, Martinique and Réunion).	The overseas departments and the overseas territories form the "French overseas communities". ⇒ Only the overseas departments have belonged to the statistical territory of the Community since 1997. ⇒ The overseas territories, regarded as non-member countries, are: •NC (809) - New Caledonia •PF (822) - French Polynesia •TF (894) - French Southern Territories •WF (811) - Wallis and Futuna ⇒ The territories under specific status are: •PM (408) - Saint Pierre and Miquelon •YT (377) - Mayotte The island of Corsica is also part of the statistical territory of France.
GA	(314)	Gabon		

Code		Text	Description	Observations
ISO	GEO			
1	2	3	4	5
GB	(006)	United Kingdom	Great Britain, Northern Ireland, Channel Islands and Isle of Man	<p>Northern Ireland is also called Ulster. The Channel Islands comprise Jersey, Guernsey, Alderney and Sark. The following territories, although dependent of the United Kingdom, appear under the following codes:</p> <ul style="list-style-type: none"> •AI (446) - Anguilla •AQ (891) - Antarctica •BM (413) - Bermuda •FK (529) - Falkland Islands (Malvinas) •GI (044) - Gibraltar •GS (893) - South Georgia and South Sandwich Islands •IO (357) - British Indian Ocean Territory •KY (463) - Cayman Islands •MS (470) - Montserrat •PN (813) - Pitcairn •SH (329) - Saint Helena •TC (454) - Turks and Caicos Islands •VG (468) - Virgin Islands, British
GD	(473)	Grenada	Including Southern Grenadines	The southern Grenadine Islands include Carriacou and Petit Martinique Islands.
GE	(076)	Georgia		<p>Until 30 June 1992 Georgia appeared under code SU (056) USSR. Georgia comprises two autonomous republics, Abkhazia and Adjara, and an autonomous province, South Ossetia.</p>
GH	(276)	Ghana		
GI	(044)	Gibraltar		See code GB (006).
GL	(406)	Greenland		Greenland has a status of internal autonomy. See code DK (008).
GM	(252)	Gambia		
GN	(260)	Guinea		Guinea includes the Los Islands off the capital, Conakry.
GQ	(310)	Equatorial Guinea		Equatorial Guinea consists of a mainland part, Mbini (formerly Río Muni), an island part, Bioko Island (formerly Fernando Póo), Annobón Island (formerly Pagalu), Corisco Island and the Elobays Islands.
GR	(009)	Greece		

Code		Text	Description	Observations
ISO	GEO			
1	2	3	4	5
GS	(893)	South Georgia and South Sandwich Islands		Formerly code XR (890) until 2000 (Polar regions) See code GB (006).
GT	(416)	Guatemala		
GU	(831)	Guam		See code US (400).
GW	(257)	Guinea-Bissau		Comprises about 60 islands including the Bijagós archipelago.
GY	(488)	Guyana		Formerly British Guiana.
HK	(740)	Hong Kong	Hong Kong Special Administrative Region of the People's Republic of China	Transfer of sovereignty to the People's Republic of China in 1997 Hong Kong principally includes Hong Kong Island, Lantau Island, the mainland peninsula of Kowloon and the New Territories.
HM	(835)	Heard Island and McDonald Islands		See code AU (800).
HN	(424)	Honduras	Including Swan Islands	Includes the Bay islands.
HR	(092)	Croatia		Until 30 June 1992 Croatia appeared under code YU (048) Yugoslavia. See code SI (091).
HT	(452)	Haiti		Haïti consists of the western part of the island of Hispaniola and Île de la Gonâve, Île de la Tortue, Île à Vache and Grande Cayemite.
HU	(064)	Hungary		
ID	(700)	Indonesia		The achipelago comprises the islands of Sumatra, Java, Bali, Flores and the western part of Timor, part of Borneo (Kalimantal), Sulawesi (Celebes), the Moluccan Islands and the western part of New Guinea (Irian Jaya).
IE	(007)	Ireland		Also known as Eire.
IL	(624)	Israel		
IN	(664)	India		Including Laccadive Island, Minicoy Island, Amindivi Island, Andaman and Nicobar Islands.

Code		Text	Description	Observations
ISO	GEO			
1	2	3	4	5
IO	(357)	British Indian Ocean Territory	Chagos Archipelago	The Chagos archipelago, a British territory since 1965, is also known as the Oil Islands. See code GB (006).
IQ	(612)	Iraq		
IR	(616)	Iran, Islamic Republic of		
IS	(024)	Iceland		
IT	(005)	Italy	Including Livigno; excluding the municipality of Campione d'Italia	Including Elba, Sardinia and Sicily. The statistical territory of Campione d'Italia is included in Switzerland. See code CH (039).
JM	(464)	Jamaica		
JO	(628)	Jordan		
JP	(732)	Japan		Comprises four major islands: Hokkaido, Honshu, Shikoku and Kyushu.
KE	(346)	Kenya		
KG	(083)	Kyrgyz, Republic		Until 30 June 1992 Kyrgyzstan appeared under code SU (056) USSR.
KH	(696)	Cambodia		
KI	(812)	Kiribati		Archipelago comprising the Gilbert, Phoenix, a part of the Ligne Islands and Banaba Island (Ocean Island) .
KM	(375)	Comoros	Anjouan, Grande Comore and Mohéli	Anjouan (Ndzouani), Grande-Comore (Ngazidja) and Mohéli (Moili); the archipelago includes a fourth island, Mayotte. See code YT (377).
KN	(449)	St Kitts and Nevis		Includes the island of St Kitts (St Christopher) and island of Nevis.
KP	(724)	Korea, Democratic People's Republic of	Often referred to as North Korea	
KR	(728)	Korea, Republic of	Often referred to as South Korea	Including Cheju Island
KW	(636)	Kuwait		Including the islands of Boûbiyan, Warbah and Failakah.

Code		Text	Description	Observations
ISO	GEO			
1	2	3	4	5
KY	(463)	Cayman Islands		The archipelago includes Grand Cayman, Little Cayman and Cayman Brac. See code GB (006).
KZ	(079)	Kazakhstan		Until 30 June 1992 Kazakhstan appeared under code SU (056) USSR.
LA	(684)	Lao People's Democratic Republic	Often referred to as Laos	
LB	(604)	Lebanon		
LC	(465)	Saint Lucia		
LI	(037)	Liechtenstein		
LK	(669)	Sri Lanka		Formerly called Ceylon.
LR	(268)	Liberia		
LS	(395)	Lesotho		Landlocked in South Africa.
LT	(055)	Lithuania		Baltic republic, independent since 1991.
LU	(018)	Luxembourg		
LV	(054)	Latvia		Baltic republic, independent since 1991.
LY	(216)	Libyan Arab Jamahiriya	Often referred to as Libya	
MA	(204)	Morocco		
MD	(074)	Moldova, Republic of		Until 30 June 1992 Moldova appeared under code SU (056) USSR.
ME	(097)	Montenegro		See code SI (091)
MG	(370)	Madagascar		Includes Nosy-Be Island.
MH	(824)	Marshall Islands		Archipelago comprising the atoll Ratak and Ralik Islands. Independent state since 1989. See code US (400).

Code		Text	Description	Observations
ISO	GEO			
1	2	3	4	5
MK ¹	(096)	Macedonia, Former Yugoslav Republic of		Until 30 June 1992 the Former Yugoslav republic of Macedonia appeared under code YU (048) Yugoslavia. See code SI (091). Provisional Code that does not affect the definitive denomination of the country to be attributed after the conclusion of the negotiations currently taking place in the United Nations.
ML	(232)	Mali		
MM	(676)	Myanmar	Often referred to as Burma	
MN	(716)	Mongolia		
MO	(743)	Macao	Special Administrative Region of the People's Republic of China	Former Portuguese overseas territory, located west of Hong Kong on the southeast coast of China. Returned to China in 1999.
MP	(820)	Northern Mariana Islands		The main islands are Saipan, Tinian and Rota. See code US (400).
MR	(228)	Mauritania		
MS	(470)	Montserrat		Part of the Leeward Islands of the Lesser Antilles. See code GB (006).
MT	(046)	Malta	Including Gozo and Comino	The archipelago consists of the islands of Gozo, Comino, Cominotto and Filfola.
MU	(373)	Mauritius	Mauritius, Rodrigues Island, Agalega Islands and Cargados Carajos Shoals (St Brandon Islands)	
MV	(667)	Maldives		
MW	(386)	Malawi		
MX	(412)	Mexico		

¹ Provisional Code that does not affect the definitive denomination of the country to be attributed after the conclusion of the negotiations currently taking place in the United Nations.

Code		Text	Description	Observations
ISO	GEO			
1	2	3	4	5
MY	(701)	Malaysia	Peninsular Malaysia and Eastern Malaysia (Labuan, Sabah and Sarawak)	Eastern Malaysia is located on the northwest coast of Borneo.
MZ	(366)	Mozambique		
NA	(389)	Namibia		Independent since 1990; before that date it was part of the territory of South Africa .
NC	(809)	New Caledonia	Including Loyalty Islands (Lifou, Maré and Ouvéa)	Includes the Belep Islands and the Isle of Pines. See code FR (001).
NE	(240)	Niger		
NF	(836)	Norfolk Island		See code AU (800).
NG	(288)	Nigeria		
NI	(432)	Nicaragua	Including Corn Islands	
NL	(003)	Netherlands		The autonomous island territories in the Caribbean which are part of the Kingdom appear under the following codes: •AN (478) - Netherlands Antilles •AW (474) - Aruba
NO	(028)	Norway	Including Svalbard Archipelago and Jan Mayen Island	The Svålbard Archipelago consists of Spitsbergen, North-East Land, Barents Island, Edge Island, Prince Charles Island, King Charles Island and Bear Island. Bouvet Island appears under code BV (892), Peter 1st Island and Queen Maud Land appear under code AQ (891).
NP	(672)	Nepal		
NR	(803)	Nauru		
NU	(838)	Niue		See code NZ (804).
NZ	(804)	New Zealand	Excluding Ross Dependency (Antarctica)	Including the Chatham Islands, the Kermadec Group and the Three Kings, Auckland, Campbell, Antipodes, Bounty and Snares Islands. The following islands, although administered by New Zealand, appear under the following codes: •CK (837) - Cook Islands •NU (838) - Niue •TK (839) - Tokelau

Code		Text	Description	Observations
ISO	GEO			
1	2	3	4	5
OM	(649)	Oman		Including part of the Moussandam peninsula.
PA	(442)	Panama	Including former Canal zone	Comprises the Las Perlas archipelago and Coiba Island.
PE	(504)	Peru		
PF	(822)	French Polynesia	Marquesas Islands, Society Islands (including Tahiti), Tuamotu Archipelago, Gambier Islands and Austral Islands. Also Clipperton Island.	Society Islands Archipelago (of which Tahiti is the most important island) comprises the Leeward and Windward island groups. Gambier Islands (main island: Mangareva). The Austral Islands comprise Tubuai, Rimatarara, Rurutu, Raivavae and Rapa. Clipperton Island, uninhabited atoll off the coast of Mexico. See code FR (001).
PG	(801)	Papua New Guinea	Eastern part of New Guinea; Bismarck Archipelago (including New Britain, New Ireland), Lavongai (New Hanover) and Admiralty Islands); Northern Solomon Islands (Bougainville and Buka); Trobriand Islands, Woodlark Island; d'Entrecasteaux Islands and Louisiade Archipelago	
PH	(708)	Philippines		The main islands are Luzon, Mindanao, Mindoro, Palawan and the archipelago of Visayas.
PK	(662)	Pakistan		
PL	(060)	Poland		
PM	(408)	Saint Pierre and Miquelon		French territorial community under specific status. See code FR (001).
PN	(813)	Pitcairn	Including the Ducie, Henderson and Oeno Islands	Under the jurisdiction of the British High Commissioner to New Zealand. See code GB (006).
PS	(625)	Palestinian Territory, Occupied	West Bank (including East Jerusalem) and Gaza Strip	

Code		Text	Description	Observations
ISO	GEO			
1	2	3	4	5
PT	(010)	Portugal	Including Azores and Madeira	The archipelago of the Azores comprises nine islands: São Miguel, Santa Maria, Terceira, Graciosa, São Jorge, Pico, Faial, Flores and Corvo. Madeira also includes the island of Porto Santo.
PW	(825)	Palau		Palau consists of the western part of the Carolines islands and comprises 26 islands, including Koror and the Babelthuap. See code US (400).
PY	(520)	Paraguay		
QA	(644)	Qatar		
QQ or	(950)	Stores and provisions	Optional heading	Delivery of ships' and aircraft's stores. - ships' and aircraft's stores means the various products for consumption by the crew and passengers of vessels or aircraft, - ships' and aircraft's supplies means the products for the operation of the engines, machines and other equipment on vessels or aircraft, such as fuel, oil and lubricants.
QR or	(951)	Stores and provisions within the framework of intra-Community trade	Optional heading	If the type of trade can be determined (intra-community or with non-member countries), code QR (951) or QS (952) is used. Only if that is not the case, can code QQ (950) be used.
QS	(952)	Stores and provisions within the framework of trade with third countries	Optional heading	
QU or	(958)	Countries and territories not specified	Optional heading	
QV or	(959)	Countries and territories not specified in the framework of intra-Community trade	Optional heading	If the type of trade can be determined (intra-community or with non-member countries), code QV (959) or QW (960) is used. Only if that it not the case, can code QU (958) be used.
QW	(960)	Countries and territories not specified within the framework of trade with third countries	Optional heading	

Code		Text	Description	Observations
ISO	GEO			
1	2	3	4	5
QX or	(977)	Countries and territories not specified for commercial or military reasons	Optional heading	If the type of trade can be determined (intra-Community or with non-member countries), code QY (978) or QZ (979) is used. If it cannot be determined for confidential commercial or military reasons, code QX (977) can be used.
QY or	(978)	Countries and territories not specified for commercial or military reasons in the framework of intra-Community trade	Optional heading	
QZ	(979)	Countries and territories not specified for commercial or military reasons in the framework of trade with third countries	Optional heading	
RO	(066)	Romania		
RU	(075)	Russian Federation	Often referred to as Russia	The Russian Federation corresponds to the former Russian Soviet Federal Socialist Republic. It also includes: ⇒ the enclave of Kaliningrad; ⇒ Franz Josef Land, Novaya Zemlya, Severnaya Zemlya, the New Siberian Islands and Wrangel Island in the Arctic Ocean; ⇒ the Kuril Islands and Sakhalin Island in the Pacific Ocean.
RW	(324)	Rwanda		
SA	(632)	Saudi Arabia		
SB	(806)	Solomon Islands		Comprises South Solomon Islands and Santa Cruz Islands.

Code		Text	Description	Observations
ISO	GEO			
1	2	3	4	5
SC	(355)	Seychelles	Mahé Island, Praslin Island, La Digue, Frégate and Silhouette; Amirante Islands (including Desroches, Alphonse, Platte and Coëtivy); Farquhar Islands (including Providence); Aldabra Islands and Cosmoledo Islands	Archipelago of 115 isles and islands.
SD	(224)	Sudan		
SE	(030)	Sweden		Also includes the islands of Gotland and Öland.
SG	(706)	Singapore		
SH	(329)	Saint Helena	Including Ascension Island and Tristan da Cunha Islands	The other islands of the Tristan da Cunha archipelago are Gough, Inaccessible and Nightingale. See code GB (006).
SI	(091)	Slovenia		Until 30 June 1992 Slovenia appeared under code YU (048) Yugoslavia. Before 1991 Slovenia was one of the republics of the Socialist Federal Republic of Yugoslavia, together with Bosnia and Herzegovina, Croatia, Macedonia, Montenegro and Serbia.
SK	(063)	Slovakia		See code CZ (061).
SL	(264)	Sierra Leone		Including Sherbro Island.
SM	(047)	San Marino		Landlocked state in Italy.
SN	(248)	Senegal		Including the island of Gorée.
SO	(342)	Somalia		
SR	(492)	Suriname		Formerly Dutch Guiana.
ST	(311)	Sao Tome and Principe		Comprises São Tomé Island and Príncipe Island and the small islands of Pedras Tinhosas and Rolas.
SV	(428)	El Salvador		
SY	(608)	Syrian Arab Republic	Often referred to as Syria	
SZ	(393)	Swaziland		Also called Ngwane.

Code		Text	Description	Observations
ISO	GEO			
1	2	3	4	5
TC	(454)	Turks and Caicos Islands		The Turks Islands consist primarily of Grand Turk and Salt Cay. See code GB (006)).
TD	(244)	Chad		
TF	(894)	French Southern Territories	Including Kerguelen Islands, Amsterdam Island, Saint Paul Island, Crozet Archipelago	See code FR (001).
TG	(280)	Togo		
TH	(680)	Thailand		
TJ	(082)	Tajikistan		Until 30 June 1992 Tajikistan appeared under code SU (056) USSR.
TK	(839)	Tokelau		See code NZ (804).
TL	(626)	Timor-Leste		
TM	(080)	Turkmenistan		Until 30 June 1992 Turkmenistan appeared under code SU (056) USSR.
TN	(212)	Tunisia		Including the island of Djerba.
TO	(817)	Tonga		Consists primarily of the Vava'u and Niua Islands, the Ha'apai and Tongatapu and Eua Islands.
TR	(052)	Turkey		
TT	(472)	Trinidad and Tobago		
TV	(807)	Tuvalu		The main atoll: Funafuti.
TW	(736)	Taiwan	Separate customs territory of Taiwan, Penghu, Kinmen and Matsu	Formerly Formosa. Including the Pescadores or Penghu Islands, Quemoy or Kinmen Island and Matsu Island.
TZ	(352)	Tanzania, United Republic of	Tanganyika, Zanzibar Island and Pemba	The main islands are Zanzibar, Pemba et Mafia. Tanganyika is the mainland part of Tanzania.
UA	(072)	Ukraine		Until 30 June 1992 Ukraine appeared under code SU (056) USSR.
UG	(350)	Uganda		

Code		Text	Description	Observations
ISO	GEO			
1	2	3	4	5
UM	(832)	United States Minor Outlying Islands	Including Baker Island, Howland Island, Jarvis Island, Johnston Atoll, Kingman Reef, Midway Islands, Navassa Island, Palmyra Atoll and Wake Island	Navassa Island was previously included in code XA (810) until 1994, and from 1995 until 2000 in code US (400). It is situated in the Antillian Sea (Atlantic Ocean), the other Islands are situated in the Pacific Ocean.
US	(400)	United States	Including Puerto Rico	Includes Alaska, the Hawaiian Islands and Navassa Island (which appeared under code XA (810) until 1994). The US is responsible for the following territories: ⇒ Puerto Rico, the Marshall Islands (code MH (824), the Federated States of Micronesia FM (823), Palau code PW (825) and the Northern Mariana Islands code MP (820), states in "free association" with the US; ⇒ American Samoa AS (830), Guam GU (831), United States Minor outlying islands UM (832), the US Virgin Islands VI (457) unincorporated territories of the United States. Puerto Rico comprises the islands of Puerto Rico, Mona, Vieques and Culebra.
UY	(524)	Uruguay		
UZ	(081)	Uzbekistan		Until 30 June 1992 Uzbekistan appeared under code SU (056) USSR.
VA	(045)	Holy See (Vatican City State)		Is not included in the statistical territory of Italy
VC	(467)	St Vincent and the Grenadines		Comprises St Vincent Island and the northern Grenadine Islands (Bequia, Canouan, Mustique, Mayreau and Union Islands).
VE	(484)	Venezuela		Including Aves Island.
VG	(468)	Virgin Islands, British		Archipelago in the Lesser Antilles consisting primarily of Tortola, Virgin Gorda, Anegada, Jost Van Dyke, Peter and Salt Islands. See code GB (006).
VI	(457)	Virgin Islands (US)		The three main islands are St Thomas, St John and St Croix. See code US (400).

Code		Text	Description	Observations
ISO	GEO			
1	2	3	4	5
VN	(690)	Viet-Nam		
VU	(816)	Vanuatu		The main islands are Santo, Malekula, Efate and Tanna.
WF	(811)	Wallis and Futuna	Including Alofi Island	Uvea is the biggest of the Wallis Islands. Futuna and Alofi comprise the Horn Islands. See code FR (001).
WS	(819)	Samoa	Formerly known as Western Samoa	Archipelago comprising primarily the Savai'i, Upolu, Apolina and Manono Islands.
XC	(021)	Ceuta		See code ES (011).
XK	(095)	Kosovo	As defined by United Nations Security Council Resolution 1244 of 10 June 1999.	
XL	(023)	Melilla	Including Peñón de Vélez de la Gomera, Peñón de Alhucemas and Chafarinas Islands	See code ES (011).
XS	(098)	Serbia		Serbia administers the autonomous province of Voïvodine. See code SI (091)
YE	(653)	Yemen	Formerly North Yemen and South Yemen	Including the islands of Kamaran, Perim and Socotra.
YT	(377)	Mayotte	Grande-Terre and Pamandzi	Also called Mahoré (Maoré) Mayotte is part of the Comoros archipelago. See code FR (001).
ZA	(388)	South Africa		Including Marion Island and Prince Edouard Island.
ZM	(378)	Zambia		
ZW	(382)	Zimbabwe		



ECONOMIC ZONES

Economic zones can overlap and must not therefore be used to construct larger groups.

Code	Text				
1000	World				
	1010	European Union (evolutionary)		5990	Miscellaneous - countries not determined
	1011	Extra-european Union (evolutionary)			
1010	European Union (evolutionary)				
	AT 038	Austria	IE 007	Ireland	
	BE 017	Belgium	IT 005	Italy	
	BG 068	Bulgaria	LT 055	Lithuania	
	CY 600	Cyprus	LU 018	Luxembourg	
	CZ 061	Czech Republic	LV 054	Latvia	
	DE 004	Germany	MT 046	Malta	
	DK 008	Denmark	NL 003	Netherlands	
	EE 053	Estonia	PL 060	Poland	
	ES 011	Spain	PT 010	Portugal	
	FI 032	Finland	RO 066	Romania	
	FR 001	France	SE 030	Sweden	
	GB 006	United Kingdom	SI 091	Slovenia	
	GR 009	Greece	SK 063	Slovakia	
	HU 064	Hungary	5910	Miscellaneous - countries not specified intra	
1011	Extra-european Union (evolutionary)				
	5190	Other European countries	5400	Asia	
	5200	Africa	5500	Oceania and Polar regions	
	5300	America	5920	Miscellaneous - countries not specified extra	
1013	Euro-zone since 1999 (evolutionary)				
	AT 038	Austria	IE 007	Ireland	
	BE 017	Belgium	IT 005	Italy	
	CY 600	Cyprus	LU 018	Luxembourg	
	DE 004	Germany	MT 046	Malta	
	ES 011	Spain	NL 003	Netherlands	
	FI 032	Finland	PT 010	Portugal	
	FR 001	France	SI 091	Slovenia	
	GR 009	Greece	SK 063	Slovakia	
			5910	Miscellaneous - countries not specified intra	
1014	Extra-euro zone since 1999 (evolutionary)				
	BG 068	Bulgaria	LT 055	Lithuania	
	CZ 061	Czech Republic	LV 054	Latvia	
	DK 008	Denmark	PL 060	Poland	
	EE 053	Estonia	RO 066	Romania	
	GB 006	United Kingdom	SE 030	Sweden	
	HU 064	Hungary	1814	Extra-european Union (27)	

Code	Text				
1021	EFTA				
	<i>European Free Trade Association</i>				
CH	039	Switzerland	LI	037	Liechtenstein
IS	024	Iceland	NO	028	Norway
1031	ACP				
	<i>African, Caribbean and Pacific countries</i>				
AG	459	Antigua and Barbuda	LS	395	Lesotho
AO	330	Angola	MG	370	Madagascar
BB	469	Barbados	MH	824	Marshall Islands
BF	236	Burkina Faso	ML	232	Mali
BI	328	Burundi	MR	228	Mauritania
BJ	284	Benin	MU	373	Mauritius
BS	453	Bahamas	MW	386	Malawi
BW	391	Botswana	MZ	366	Mozambique
BZ	421	Belize	NA	389	Namibia
CD	322	Congo, Democratic Republic of	NE	240	Niger
CF	306	Central African Republic	NG	288	Nigeria
CG	318	Congo	NR	803	Nauru
CI	272	Côte d'Ivoire	NU	838	Niue
CK	837	Cook Islands	PG	801	Papua New Guinea
CM	302	Cameroon	PW	825	Palau
CU	448	Cuba	RW	324	Rwanda
CV	247	Cape Verde	SB	806	Solomon Islands
DJ	338	Djibouti	SC	355	Seychelles
DM	460	Dominica	SD	224	Sudan
DO	456	Dominican Republic	SL	264	Sierra Leone
ER	336	Eritrea	SN	248	Senegal
ET	334	Ethiopia	SO	342	Somalia
FJ	815	Fiji	SR	492	Suriname
FM	823	Micronesia, Federated States of	ST	311	Sao Tome and Principe
GA	314	Gabon	SZ	393	Swaziland
GD	473	Grenada	TD	244	Chad
GH	276	Ghana	TG	280	Togo
GM	252	Gambia	TL	626	Timor-Leste
GN	260	Guinea	TO	817	Tonga
GQ	310	Equatorial Guinea	TT	472	Trinidad and Tobago
GW	257	Guinea-Bissau	TV	807	Tuvalu
GY	488	Guyana	TZ	352	Tanzania, United Republic of
HT	452	Haiti	UG	350	Uganda
JM	464	Jamaica	VC	467	St Vincent and the Grenadines
KE	346	Kenya	VU	816	Vanuatu
KI	812	Kiribati	WS	819	Samoa
KM	375	Comoros	ZA	388	South Africa
KN	449	St Kitts and Nevis	ZM	378	Zambia
LC	465	Saint Lucia	ZW	382	Zimbabwe
LR	268	Liberia			
1051	Mediterranean basin countries (excluding EU)				
AL	070	Albania	ME	097	Montenegro
BA	093	Bosnia and Herzegovina	MK	096	Macedonia, Former Yugoslav Republic of
DZ	208	Algeria	PS	625	Palestinian Territory, Occupied

Code	Text				
EG	220	Egypt	SY	608	Syrian Arab Republic
GI	044	Gibraltar	TN	212	Tunisia
HR	092	Croatia	TR	052	Turkey
IL	624	Israel	XC	021	Ceuta
JO	628	Jordan	XK	095	Kosovo
LB	604	Lebanon	XL	023	Melilla
LY	216	Libyan Arab Jamahiriya	XS	098	Serbia
MA	204	Morocco			
1053 OPEC					
<i>Organisation of Petroleum Exporting Countries</i>					
AE	647	United Arab Emirates	KW	636	Kuwait
AO	330	Angola	LY	216	Libyan Arab Jamahiriya
DZ	208	Algeria	NG	288	Nigeria
EC	500	Ecuador	QA	644	Qatar
IQ	612	Iraq	SA	632	Saudi Arabia
IR	616	Iran, Islamic Republic of	VE	484	Venezuela
1055 MEDA					
<i>Union for the Mediterranean (excluding EU)</i>					
AL	070	Albania	MA	204	Morocco
BA	093	Bosnia and Herzegovina	ME	097	Montenegro
DZ	208	Algeria	MR	228	Mauritania
EG	220	Egypt	PS	625	Palestinian Territory, Occupied
HR	092	Croatia	SY	608	Syrian Arab Republic
IL	624	Israel	TN	212	Tunisia
JO	628	Jordan	TR	052	Turkey
LB	604	Lebanon			
1057 ASEAN					
<i>Association of South-East Asian Nations</i>					
BN	703	Brunei Darussalam	MY	701	Malaysia
ID	700	Indonesia	PH	708	Philippines
KH	696	Cambodia	SG	706	Singapore
LA	684	Lao People's Democratic Republic	TH	680	Thailand
MM	676	Myanmar	VN	690	Viet-Nam
1058 Latin American countries					
AR	528	Argentina	HN	424	Honduras
BO	516	Bolivia	HT	452	Haiti
BR	508	Brazil	MX	412	Mexico
CL	512	Chile	NI	432	Nicaragua
CO	480	Colombia	PA	442	Panama
CR	436	Costa Rica	PE	504	Peru
CU	448	Cuba	PY	520	Paraguay
DO	456	Dominican Republic	SV	428	El Salvador
EC	500	Ecuador	UY	524	Uruguay
GT	416	Guatemala	VE	484	Venezuela
1059 SAARC					
<i>South Asian Association for Regional Cooperation</i>					
AF	660	Afghanistan	LK	669	Sri Lanka
BD	666	Bangladesh	MV	667	Maldives
BT	675	Bhutan	NP	672	Nepal
IN	664	India	PK	662	Pakistan

Code	Text					
1110	European Union (15)					
	AT	038	Austria	GR	009	Greece
	BE	017	Belgium	IE	007	Ireland
	DE	004	Germany	IT	005	Italy
	DK	008	Denmark	LU	018	Luxembourg
	ES	011	Spain	NL	003	Netherlands
	FI	032	Finland	PT	010	Portugal
	FR	001	France	SE	030	Sweden
	GB	006	United Kingdom		5910	Miscellaneous - countries not specified intra
1111	European Union (25)					
	AT	038	Austria	IE	007	Ireland
	BE	017	Belgium	IT	005	Italy
	CY	600	Cyprus	LT	055	Lithuania
	CZ	061	Czech Republic	LU	018	Luxembourg
	DE	004	Germany	LV	054	Latvia
	DK	008	Denmark	MT	046	Malta
	EE	053	Estonia	NL	003	Netherlands
	ES	011	Spain	PL	060	Poland
	FI	032	Finland	PT	010	Portugal
	FR	001	France	SE	030	Sweden
	GB	006	United Kingdom	SI	091	Slovenia
	GR	009	Greece	SK	063	Slovakia
	HU	064	Hungary		5910	Miscellaneous - countries not specified intra
1112	European Union (27)					
	BG	068	Bulgaria		1111	European Union (25)
	RO	066	Romania			
1113	Euro-zone (12)					
	AT	038	Austria	IE	007	Ireland
	BE	017	Belgium	IT	005	Italy
	DE	004	Germany	LU	018	Luxembourg
	ES	011	Spain	NL	003	Netherlands
	FI	032	Finland	PT	010	Portugal
	FR	001	France		5910	Miscellaneous - countries not specified intra
	GR	009	Greece			
1114	Euro-zone (13)					
	SI	091	Slovenia		1113	Euro-zone (12)
1115	EEA					
	<i>European Economic Area</i>					
	IS	024	Iceland	NO	028	Norway
	LI	037	Liechtenstein		1010	European Union (evolutionary)
1116	Euro-zone (15)					
	CY	600	Cyprus		1114	Euro-zone (13)
	MT	046	Malta			
1117	Euro-zone (16)					
	SK	063	Slovakia		1116	Euro-zone (15)

Code	Text					
1118	Extra-euro zone (16)					
BG	068	Bulgaria	LT	055	Lithuania	
CZ	061	Czech Republic	LV	054	Latvia	
DK	008	Denmark	PL	060	Poland	
EE	053	Estonia	RO	066	Romania	
GB	006	United Kingdom	SE	030	Sweden	
HU	064	Hungary		1817	Extra-euro zone (15)	
1120	WBCs					
<i>Western Balkan Countries</i>						
AL	070	Albania	MK	096	Macedonia, Former Yugoslav Republic	
BA	093	Bosnia and Herzegovina	XK	095	Kosovo	
HR	092	Croatia	XS	098	Serbia	
ME	097	Montenegro				
1130	Candidate countries					
HR	092	Croatia	TR	052	Turkey	
MK	096	Macedonia, Former Yugoslav Republic of				
1310	NAFTA					
<i>North American Free Trade Agreement</i>						
CA	404	Canada	US	400	United States	
MX	412	Mexico				
1330	MERCOSUR					
<i>South American Common Market</i>						
AR	528	Argentina	PY	520	Paraguay	
BR	508	Brazil	UY	524	Uruguay	
1410	NICs					
<i>Newly-industrialised Asian countries</i>						
HK	740	Hong Kong	SG	706	Singapore	
KR	728	Korea, Republic of	TW	736	Taiwan	
1415	DAEs					
<i>Dynamic Asian economies</i>						
HK	740	Hong Kong	SG	706	Singapore	
KR	728	Korea, Republic of	TH	680	Thailand	
MY	701	Malaysia	TW	736	Taiwan	
1420	APEC					
<i>Asia Pacific Economic Cooperation</i>						
AU	800	Australia	NZ	804	New Zealand	
BN	703	Brunei Darussalam	PE	504	Peru	
CA	404	Canada	PG	801	Papua New Guinea	
CL	512	Chile	PH	708	Philippines	
CN	720	China	RU	075	Russian Federation	
HK	740	Hong Kong	SG	706	Singapore	
ID	700	Indonesia	TH	680	Thailand	
JP	732	Japan	TW	736	Taiwan	
KR	728	Korea, Republic of	US	400	United States	
MX	412	Mexico	VN	690	Viet-Nam	
MY	701	Malaysia				

Code	Text				
1430	LDC				
	<i>Least Developed Countries</i>				
AF	660	Afghanistan	MM	676	Myanmar
AO	330	Angola	MR	228	Mauritania
BD	666	Bangladesh	MV	667	Maldives
BF	236	Burkina Faso	MW	386	Malawi
BI	328	Burundi	MZ	366	Mozambique
BJ	284	Benin	NE	240	Niger
BT	675	Bhutan	NP	672	Nepal
CD	322	Congo, Democratic Republic of	RW	324	Rwanda
CF	306	Central African Republic	SB	806	Solomon Islands
DJ	338	Djibouti	SD	224	Sudan
ER	336	Eritrea	SL	264	Sierra Leone
ET	334	Ethiopia	SN	248	Senegal
GM	252	Gambia	SO	342	Somalia
GN	260	Guinea	ST	311	Sao Tome and Principe
GQ	310	Equatorial Guinea	TD	244	Chad
GW	257	Guinea-Bissau	TG	280	Togo
HT	452	Haiti	TL	626	Timor-Leste
KH	696	Cambodia	TV	807	Tuvalu
KI	812	Kiribati	TZ	352	Tanzania, United Republic of
KM	375	Comoros	UG	350	Uganda
LA	684	Lao People's Democratic Republic	VU	816	Vanuatu
LR	268	Liberia	WS	819	Samoa
LS	395	Lesotho	YE	653	Yemen
MG	370	Madagascar	ZM	378	Zambia
ML	232	Mali			
1811	Extra-European Union (15)				
CY	600	Cyprus	MT	046	Malta
CZ	061	Czech Republic	PL	060	Poland
EE	053	Estonia	SI	091	Slovenia
HU	064	Hungary	SK	063	Slovakia
LT	055	Lithuania		1812	Extra-European Union (25)
LV	054	Latvia			
1812	Extra-European Union (25)				
AD	043	Andorra	NO	028	Norway
AL	070	Albania	RO	066	Romania
BA	093	Bosnia and Herzegovina	RU	075	Russian Federation
BG	068	Bulgaria	SM	047	San Marino
BY	073	Belarus	TR	052	Turkey
CH	039	Switzerland	UA	072	Ukraine
FO	041	Faroe Islands	VA	045	Holy See (Vatican City State)
GI	044	Gibraltar	XK	095	Kosovo
HR	092	Croatia	XS	098	Serbia
IS	024	Iceland		5200	Africa
LI	037	Liechtenstein		5300	America
MD	074	Moldova, Republic of		5400	Asia
ME	097	Montenegro		5500	Oceania and Polar regions
MK	096	Macedonia, Former Yugoslav Republic of		5920	Miscellaneous - countries not specified extra

Code	Text					
1813	Extra-euro-zone (12)					
	DK	008	Denmark	SE	030	Sweden
	GB	006	United Kingdom		1811	Extra-european Union (15)
1814	Extra-European Union (27)					
	AD	043	Andorra	NO	028	Norway
	AL	070	Albania	RU	075	Russian Federation
	BA	093	Bosnia and Herzegovina	SM	047	San Marino
	BY	073	Belarus	TR	052	Turkey
	CH	039	Switzerland	UA	072	Ukraine
	FO	041	Faroe Islands	VA	045	Holy See (Vatican City State)
	GI	044	Gibraltar	XK	095	Kosovo
	HR	092	Croatia	XS	098	Serbia
	IS	024	Iceland		5200	Africa
	LI	037	Liechtenstein		5300	America
	MD	074	Moldova, Republic of		5400	Asia
	ME	097	Montenegro		5500	Oceania and Polar regions
	MK	096	Macedonia, Former Yugoslav Republic		5920	Miscellaneous - countries not specified extra
1815	CIS					
	<i>Commonwealth of Independent States</i>					
	AM	077	Armenia	RU	075	Russian Federation
	AZ	078	Azerbaijan	TJ	082	Tajikistan
	BY	073	Belarus	TM	080	Turkmenistan
	KG	083	Kyrgyz, Republic	UA	072	Ukraine
	KZ	079	Kazakhstan	UZ	081	Uzbekistan
	MD	074	Moldova, Republic of			
1816	Extra-euro-zone (13)					
	BG	068	Bulgaria	LV	054	Latvia
	CY	600	Cyprus	MT	046	Malta
	CZ	061	Czech Republic	PL	060	Poland
	DK	008	Denmark	RO	066	Romania
	EE	053	Estonia	SE	030	Sweden
	GB	006	United Kingdom	SK	063	Slovakia
	HU	064	Hungary		1814	Extra-european Union (27)
	LT	055	Lithuania			
1817	Extra-euro-zone (15)					
	BG	068	Bulgaria	LV	054	Latvia
	CZ	061	Czech Republic	PL	060	Poland
	DK	008	Denmark	RO	066	Romania
	EE	053	Estonia	SE	030	Sweden
	GB	006	United Kingdom	SK	063	Slovakia
	HU	064	Hungary		1814	Extra-european Union (27)
	LT	055	Lithuania			

Code	Text				
1820	OECD (excluding EU)				
	<i>Organisation for Economic Cooperation and Development, excluding EU</i>				
AU	800	Australia	MX	412	Mexico
CA	404	Canada	NO	028	Norway
CH	039	Switzerland	NZ	804	New Zealand
IS	024	Iceland	TR	052	Turkey
JP	732	Japan	US	400	United States
KR	728	Korea, Republic of	VI	457	Virgin Islands (US)



GEOGRAPHICAL ZONES

Geographic areas of the same level do not overlap.

Code	Text	
5000	World	
	5100	Europe
	5200	Africa
	5300	America
	5400	Asia
	5500	Oceania and Polar regions
	5920	Miscellaneous - countries not specified extra
	5990	Miscellaneous - countries not determined
5100	Europe	
	5110	European Union
	5190	Other European countries
5110	European Union	
AT	038	Austria
BE	017	Belgium
BG	068	Bulgaria
CY	600	Cyprus
CZ	061	Czech Republic
DE	004	Germany
DK	008	Denmark
EE	053	Estonia
ES	011	Spain
FI	032	Finland
FR	001	France
GB	006	United Kingdom
GR	009	Greece
HU	064	Hungary
IE	007	Ireland
IT	005	Italy
LT	055	Lithuania
LU	018	Luxembourg
LV	054	Latvia
MT	046	Malta
NL	003	Netherlands
PL	060	Poland
PT	010	Portugal
RO	066	Romania
SE	030	Sweden
SI	091	Slovenia
SK	063	Slovakia
	5910	Miscellaneous - countries not specified intra
5190	Other European countries	
AD	043	Andorra
AL	070	Albania
BA	093	Bosnia and Herzegovina
BY	073	Belarus
CH	039	Switzerland
FO	041	Faroe Islands
GI	044	Gibraltar
HR	092	Croatia
IS	024	Iceland
LI	037	Liechtenstein
MD	074	Moldova, Republic of
ME	097	Montenegro
MK	096	Macedonia, Former Yugoslav Republic of
NO	028	Norway
RU	075	Russian Federation
SM	047	San Marino
TR	052	Turkey
UA	072	Ukraine
VA	045	Holy See (Vatican City State)
XK	095	Kosovo
XS	098	Serbia
5200	Africa	
	5210	North Africa
	5290	Other African countries
5210	North Africa	
DZ	208	Algeria
EG	220	Egypt
LY	216	Libyan Arab Jamahiriya
MA	204	Morocco
TN	212	Tunisia
XC	021	Ceuta
XL	023	Melilla

Code	Text				
5290	Other African countries				
AO	330	Angola	ML	232	Mali
BF	236	Burkina Faso	MR	228	Mauritania
BI	328	Burundi	MU	373	Mauritius
BJ	284	Benin	MW	386	Malawi
BW	391	Botswana	MZ	366	Mozambique
CD	322	Congo, Democratic Republic of	NA	389	Namibia
CF	306	Central African Republic	NE	240	Niger
CG	318	Congo	NG	288	Nigeria
CI	272	Côte d'Ivoire	RW	324	Rwanda
CM	302	Cameroon	SC	355	Seychelles
CV	247	Cape Verde	SD	224	Sudan
DJ	338	Djibouti	SH	329	Saint Helena
ER	336	Eritrea	SL	264	Sierra Leone
ET	334	Ethiopia	SN	248	Senegal
GA	314	Gabon	SO	342	Somalia
GH	276	Ghana	ST	311	Sao Tome and Principe
GM	252	Gambia	SZ	393	Swaziland
GN	260	Guinea	TD	244	Chad
GQ	310	Equatorial Guinea	TG	280	Togo
GW	257	Guinea-Bissau	TZ	352	Tanzania, United Republic of
IO	357	British Indian Ocean Territory	UG	350	Uganda
KE	346	Kenya	YT	377	Mayotte
KM	375	Comoros	ZA	388	South Africa
LR	268	Liberia	ZM	378	Zambia
LS	395	Lesotho	ZW	382	Zimbabwe
MG	370	Madagascar			
5300	America				
	5310	North America		5330	South America
	5320	Central America and Caribbean			
5310	North America				
CA	404	Canada	PM	408	Saint Pierre and Miquelon
GL	406	Greenland	US	400	United States
5320	Central America and Caribbean				
AG	459	Antigua and Barbuda	HT	452	Haiti
AI	446	Anguilla	JM	464	Jamaica
AN	478	Netherlands Antilles	KN	449	St Kitts and Nevis
AW	474	Aruba	KY	463	Cayman Islands
BB	469	Barbados	LC	465	Saint Lucia
BM	413	Bermuda	MS	470	Montserrat
BS	453	Bahamas	MX	412	Mexico
BZ	421	Belize	NI	432	Nicaragua
CR	436	Costa Rica	PA	442	Panama
CU	448	Cuba	SV	428	El Salvador
DM	460	Dominica	TC	454	Turks and Caicos Islands
DO	456	Dominican Republic	TT	472	Trinidad and Tobago
GD	473	Grenada	VC	467	St Vincent and the Grenadines
GT	416	Guatemala	VG	468	Virgin Islands, British
HN	424	Honduras	VI	457	Virgin Islands (US)

Code	Text				
5330	South America				
AR	528	Argentina	GY	488	Guyana
BO	516	Bolivia	PE	504	Peru
BR	508	Brazil	PY	520	Paraguay
CL	512	Chile	SR	492	Suriname
CO	480	Colombia	UY	524	Uruguay
EC	500	Ecuador	VE	484	Venezuela
FK	529	Falkland Islands (Malvinas)			
5400	Asia				
	5410	Near and Middle Eastern countries		5490	Other Asian countries
5410	Near and Middle Eastern countries				
AE	647	United Arab Emirates	KW	636	Kuwait
AM	077	Armenia	LB	604	Lebanon
AZ	078	Azerbaijan	OM	649	Oman
BH	640	Bahrain	PS	625	Palestinian Territory, Occupied
GE	076	Georgia	QA	644	Qatar
IL	624	Israel	SA	632	Saudi Arabia
IQ	612	Iraq	SY	608	Syrian Arab Republic
IR	616	Iran, Islamic Republic of	YE	653	Yemen
JO	628	Jordan			
5490	Other Asian countries				
AF	660	Afghanistan	MM	676	Myanmar
BD	666	Bangladesh	MN	716	Mongolia
BN	703	Brunei Darussalam	MO	743	Macao
BT	675	Bhutan	MV	667	Maldives
CN	720	China	MY	701	Malaysia
HK	740	Hong Kong	NP	672	Nepal
ID	700	Indonesia	PH	708	Philippines
IN	664	India	PK	662	Pakistan
JP	732	Japan	SG	706	Singapore
KG	083	Kyrgyz, Republic	TH	680	Thailand
KH	696	Cambodia	TJ	082	Tajikistan
KP	724	Korea, Democratic People's Republic of	TL	626	Timor-Leste
KR	728	Korea, Republic of	TM	080	Turkmenistan
KZ	079	Kazakhstan	TW	736	Taiwan
LA	684	Lao People's Democratic Republic	UZ	081	Uzbekistan
LK	669	Sri Lanka	VN	690	Viet-Nam
5500	Oceania and Polar regions				
	5510	Australia and New Zealand		5590	Other countries of Oceania and Polar regions
5510	Australia and New Zealand				
AU	800	Australia	NF	836	Norfolk Island
CC	833	Cocos (Keeling), Islands	NU	838	Niue
CK	837	Cook Islands	NZ	804	New Zealand
CX	834	Christmas Island	TK	839	Tokelau
HM	835	Heard Island and McDonald Islands			

Code	Text				
5590	Other countries of Oceania and Polar regions				
AQ	891	Antarctica	PF	822	French Polynesia
AS	830	American Samoa	PG	801	Papua New Guinea
BV	892	Bouvet Island	PN	813	Pitcairn
FJ	815	Fiji	PW	825	Palau
FM	823	Micronesia, Federated States of	SB	806	Solomon Islands
GS	893	South Georgia and South Sandwich Islands	TF	894	French Southern Territories
GU	831	Guam	TO	817	Tonga
KI	812	Kiribati	TV	807	Tuvalu
MH	824	Marshall Islands	UM	832	United States Minor Outlying Islands
MP	820	Northern Mariana Islands	VU	816	Vanuatu
NC	809	New Caledonia	WF	811	Wallis and Futuna
NR	803	Nauru	WS	819	Samoa
5900	Miscellaneous - countries not specified and countries not determined				
	5910	Miscellaneous - countries not specified intra		5990	Miscellaneous - countries not determined
	5920	Miscellaneous - countries not specified extra			
5910	Miscellaneous - countries not specified intra				
QR	951	Stores and provisions within the framework of intra-Community trade	QY	978	Countries and territories not specified for commercial or military reasons in the framework of intra-Community trade
QV	959	Countries and territories not specified in the framework of intra-Community trade			
5920	Miscellaneous - countries not specified extra				
QS	952	Stores and provisions within the framework of trade with third countries	QZ	979	Countries and territories not specified for commercial or military reasons in the framework of trade with third countries
QW	960	Countries and territories not specified within the framework of trade with third countries			
5990	Miscellaneous - countries not determined				
QQ	950	Stores and provisions	QX	977	Countries and territories not specified for commercial or military reasons
QU	958	Countries and territories not specified			



DEVELOPMENT OF CODES

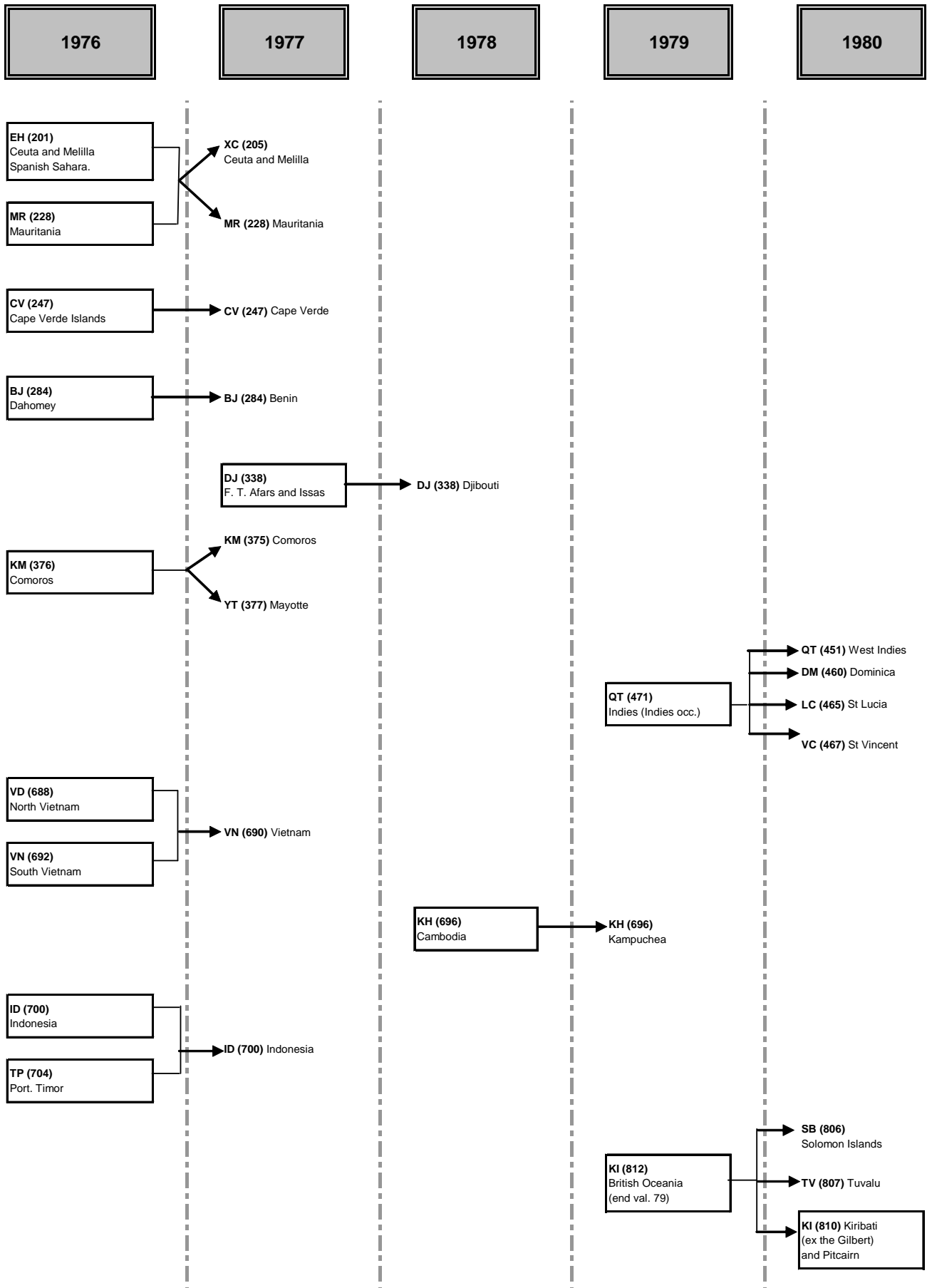

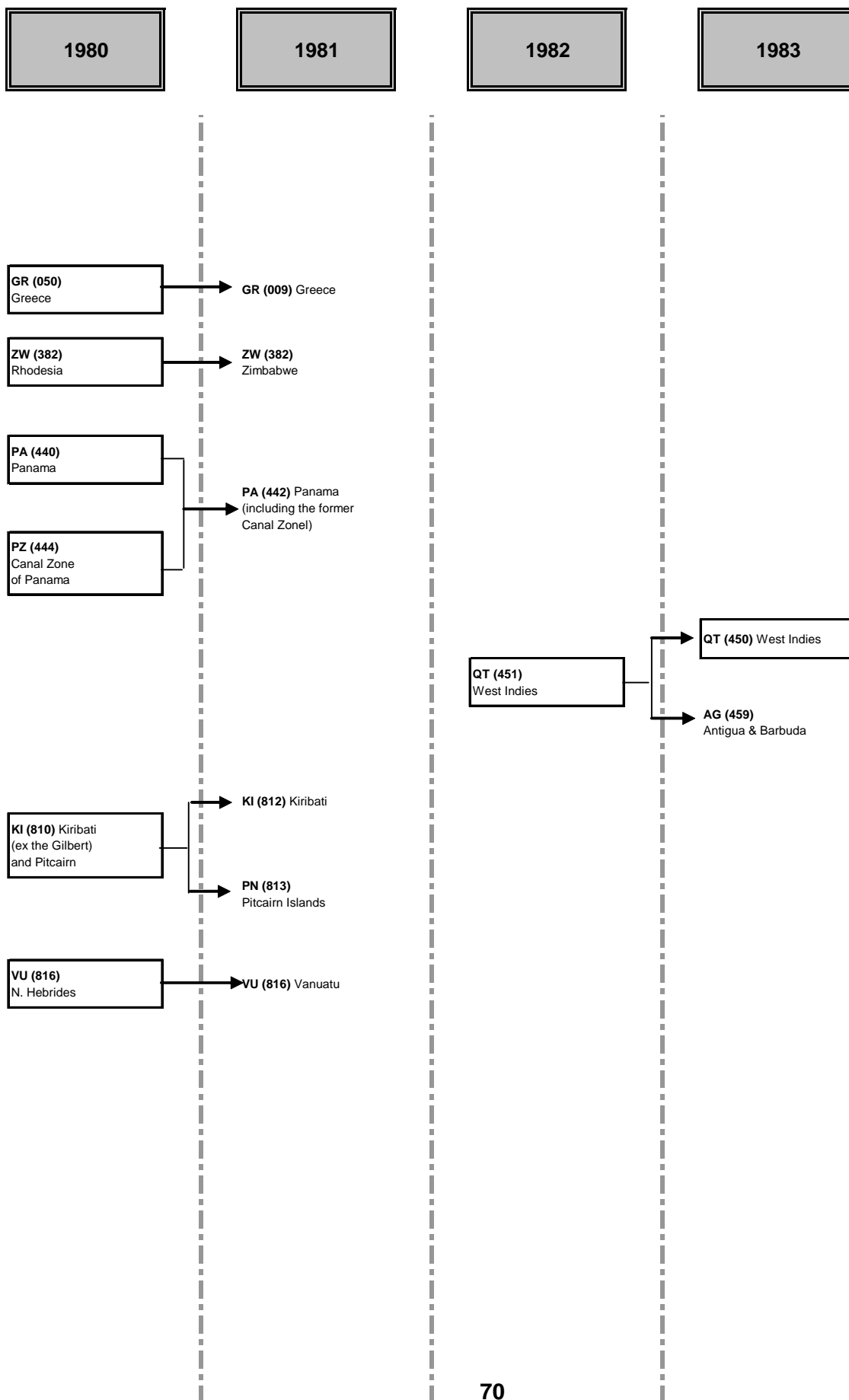

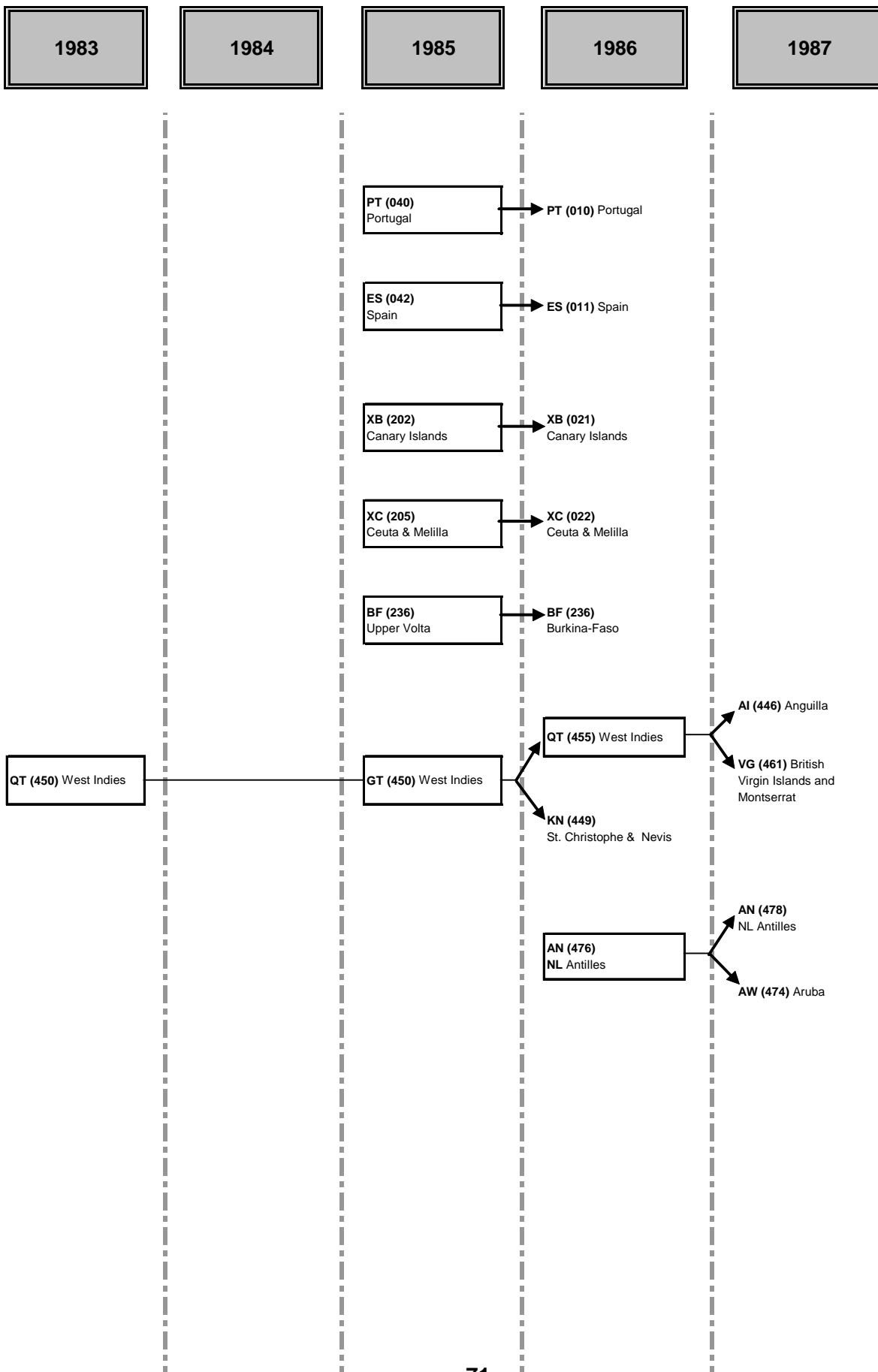

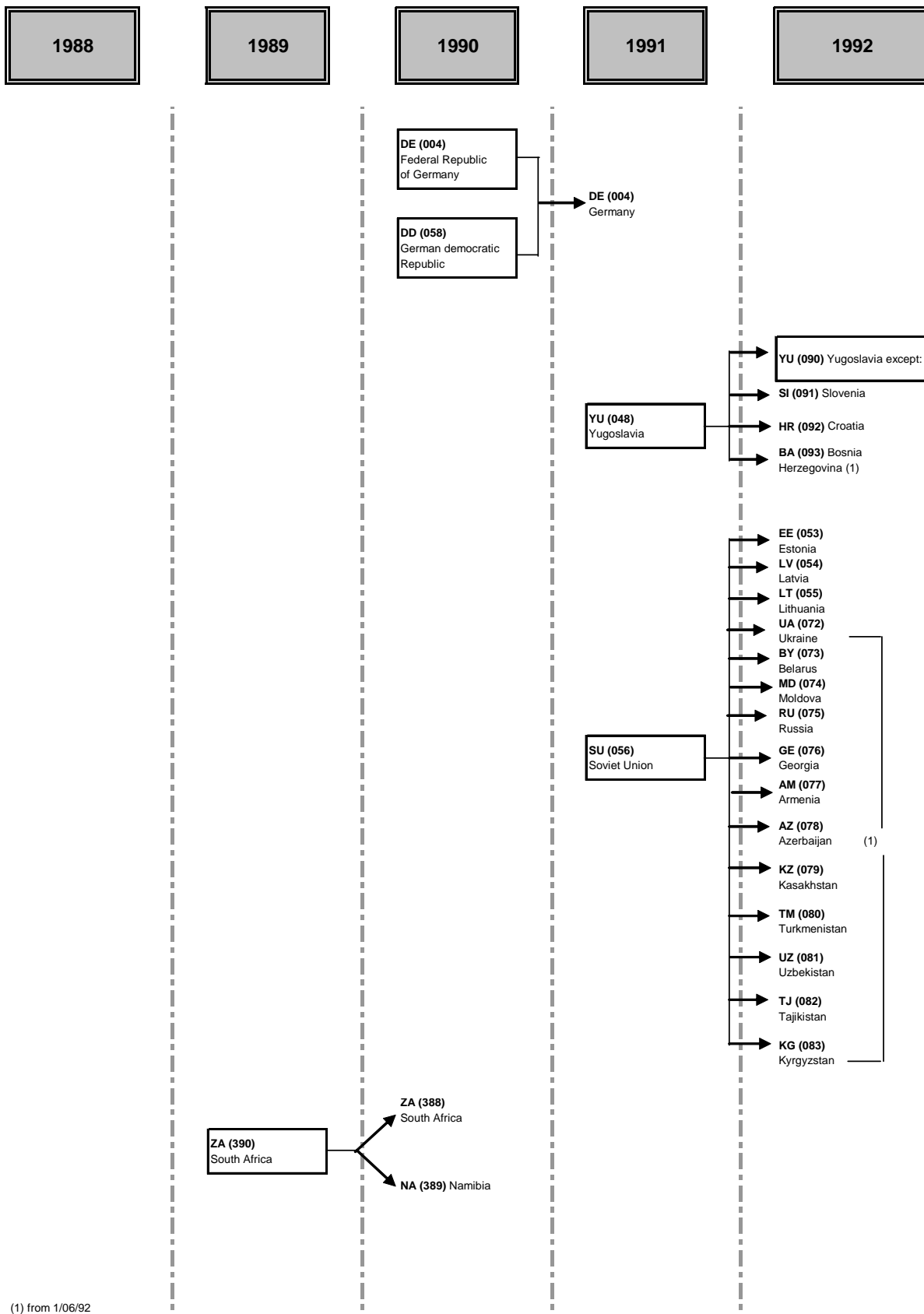

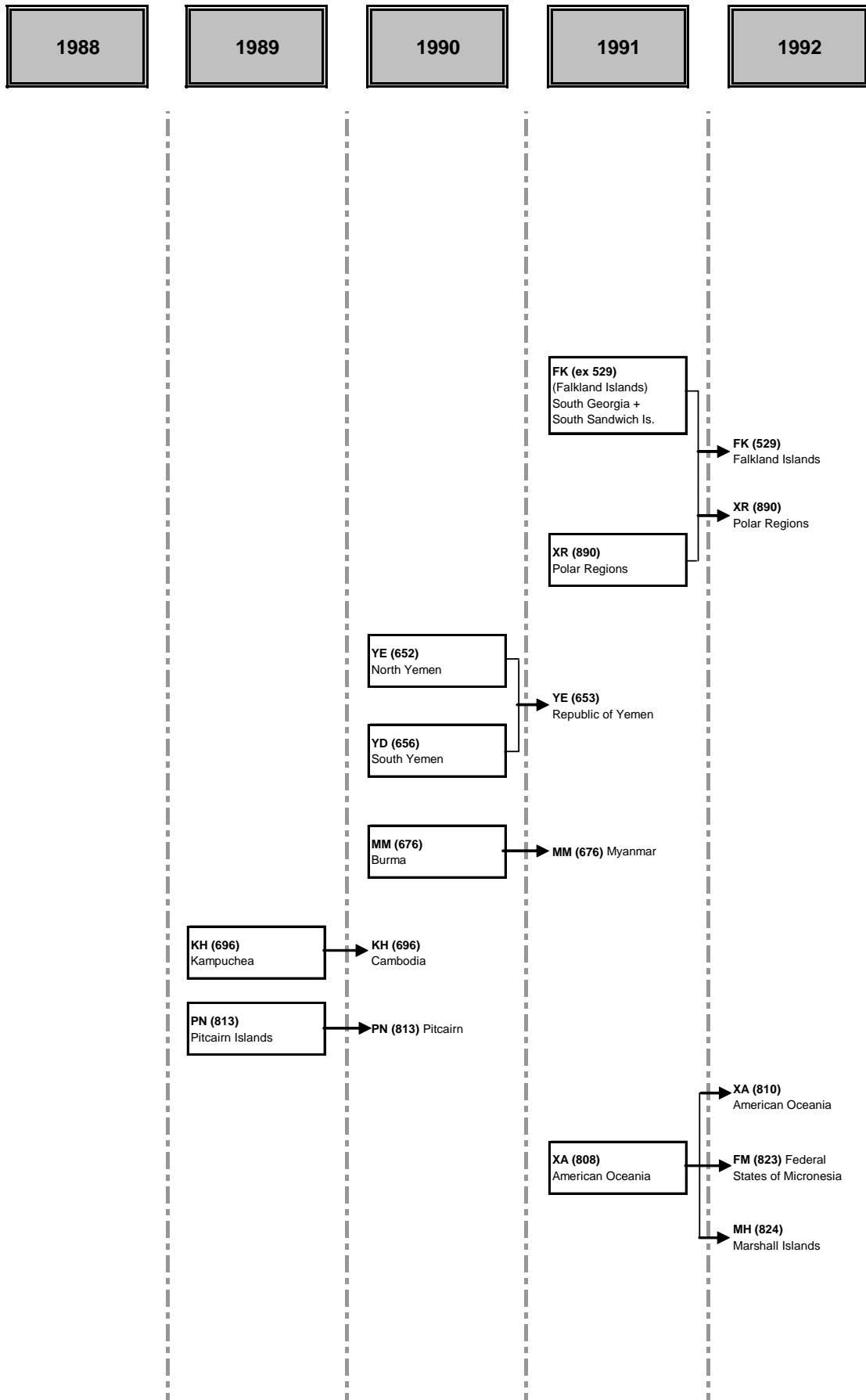

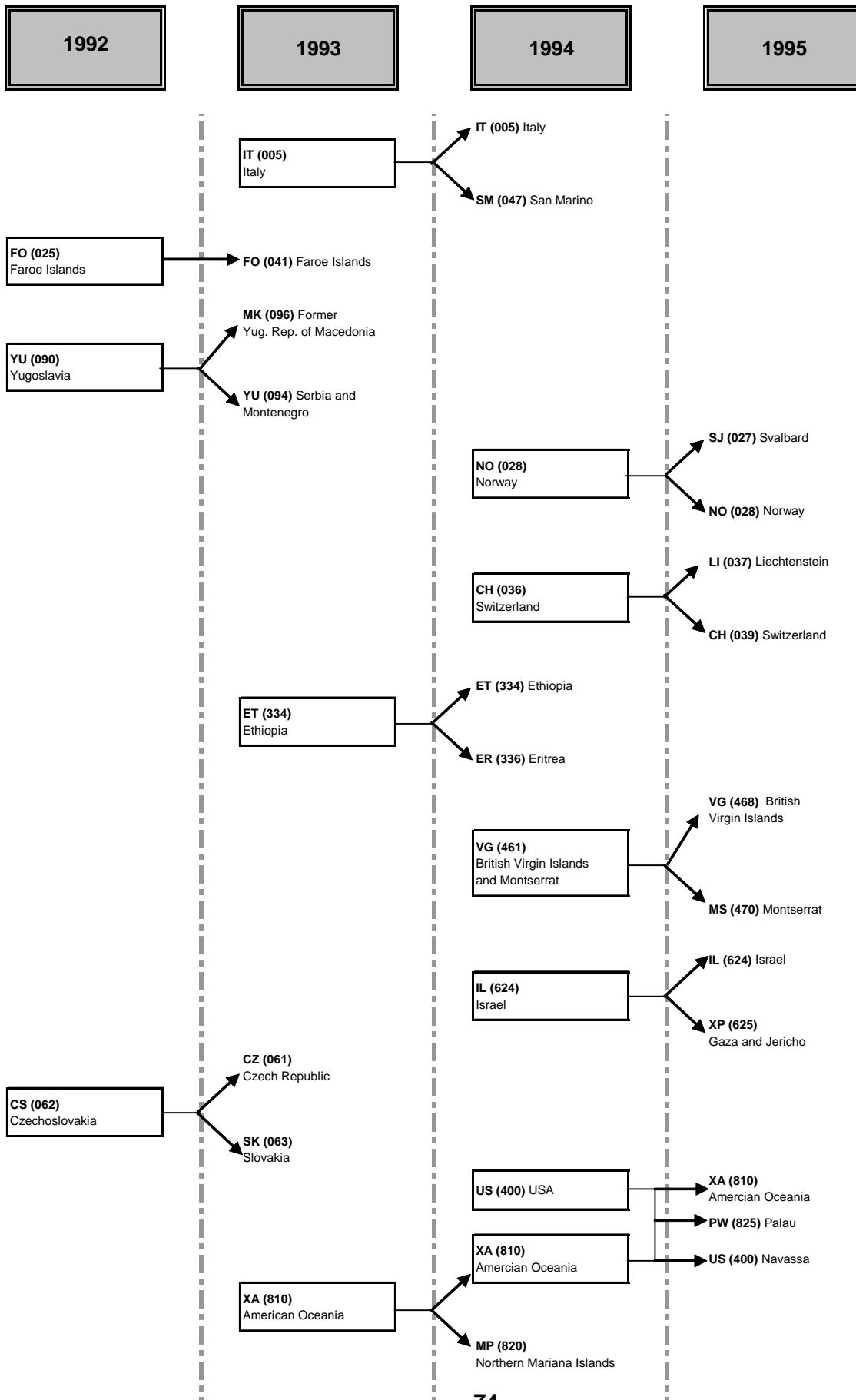

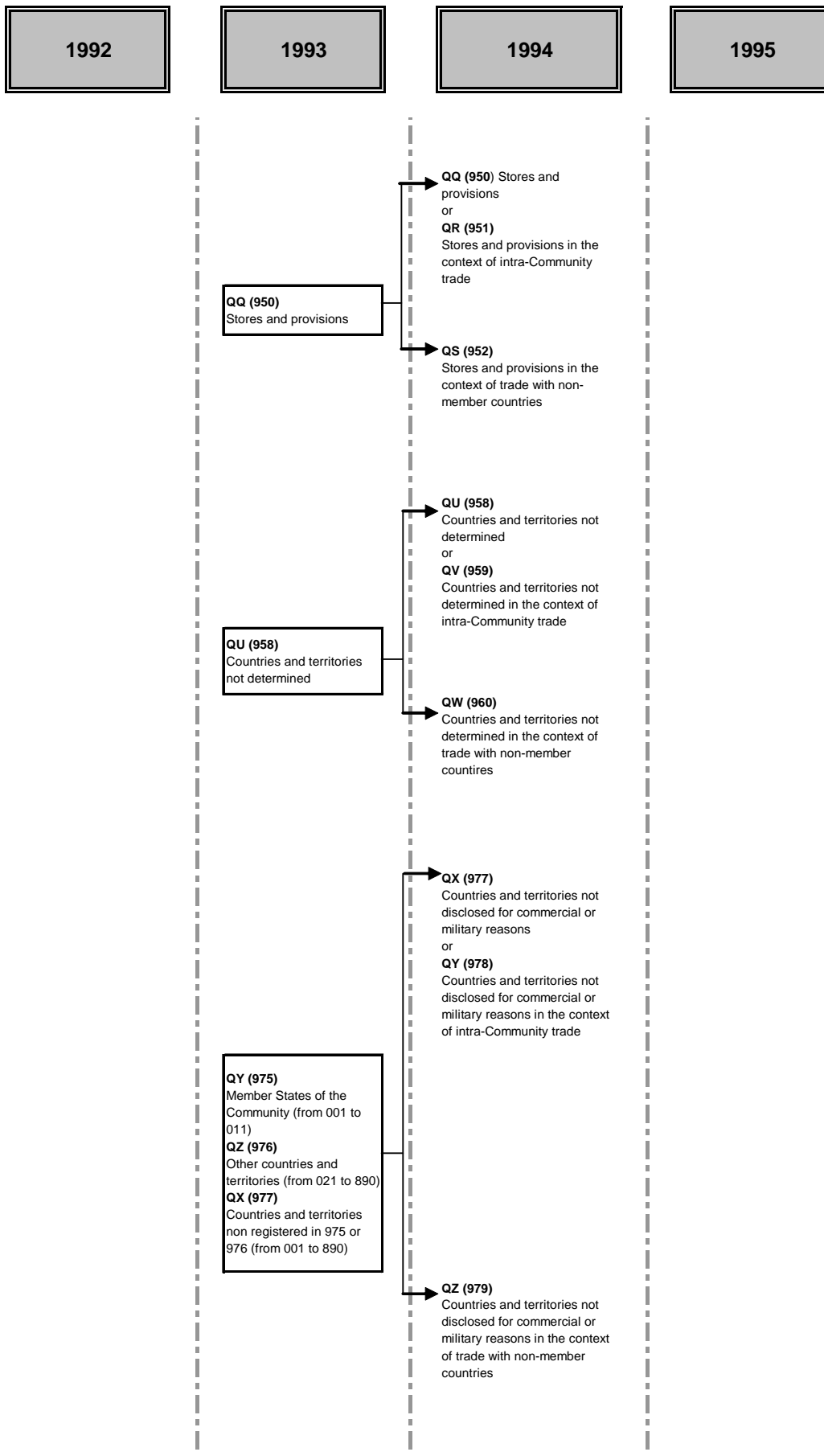

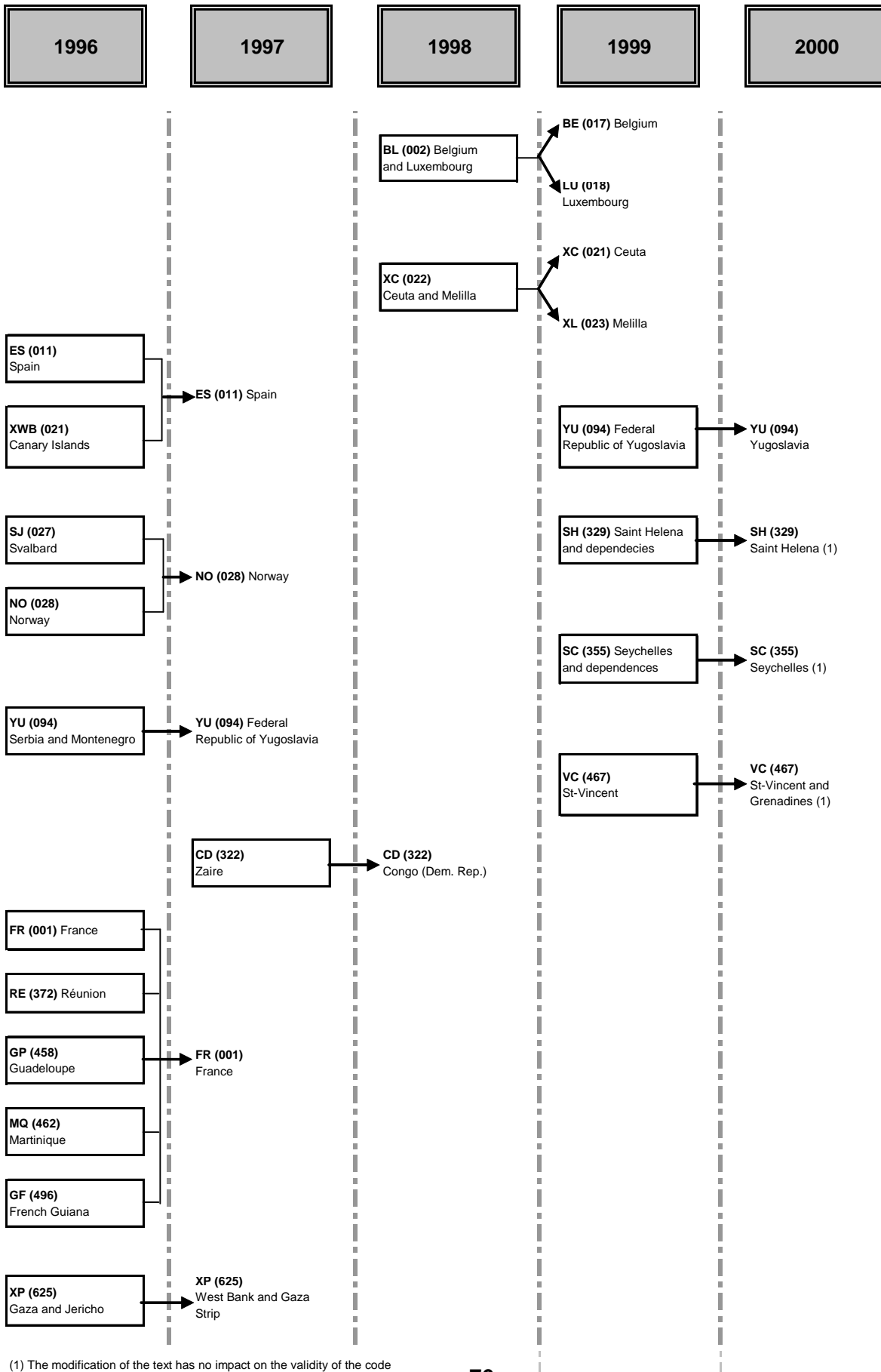

(1) The modification of the text has no impact on the validity of the code

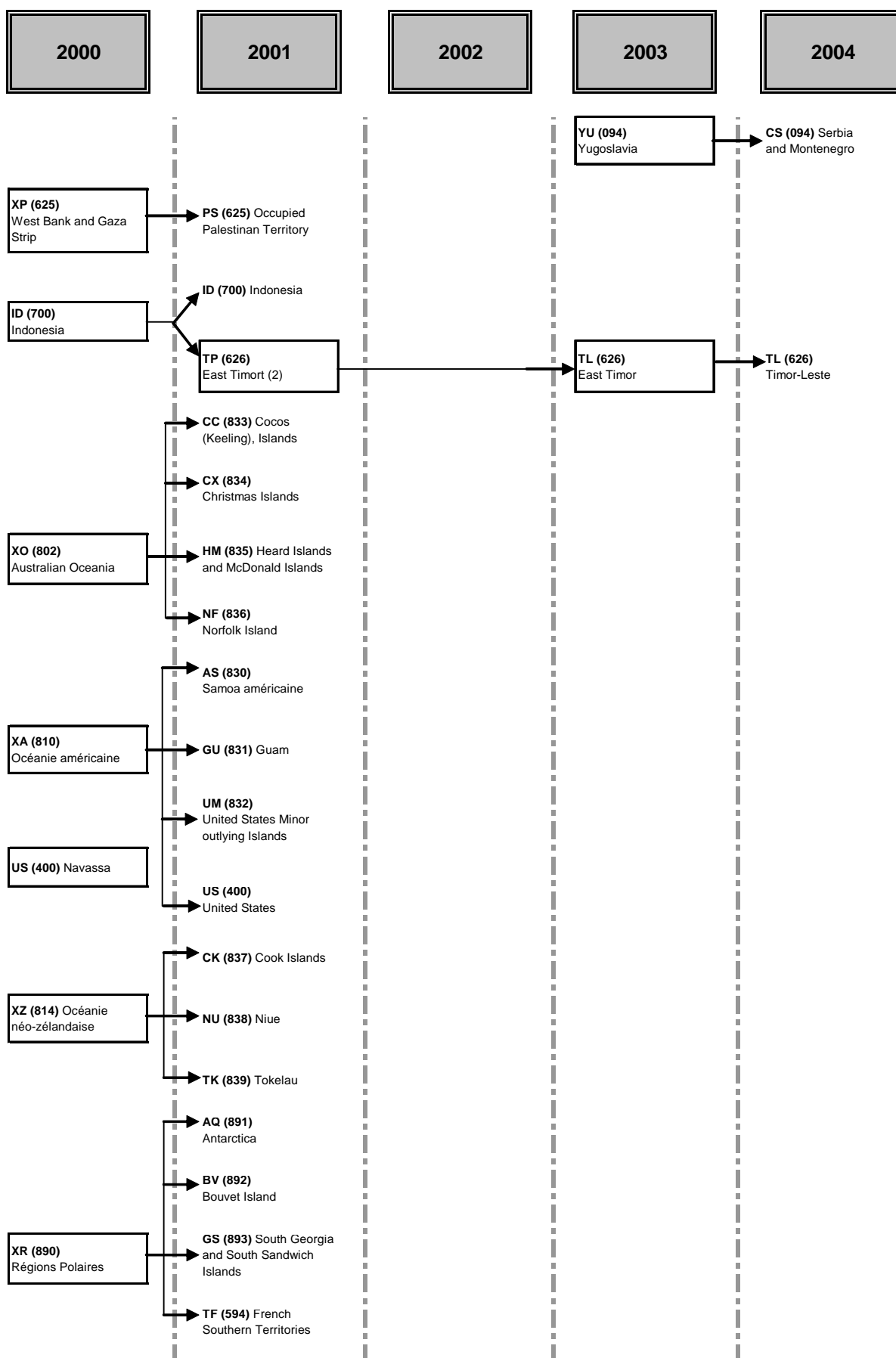

(2) Territory under United Nations transitoriel administration

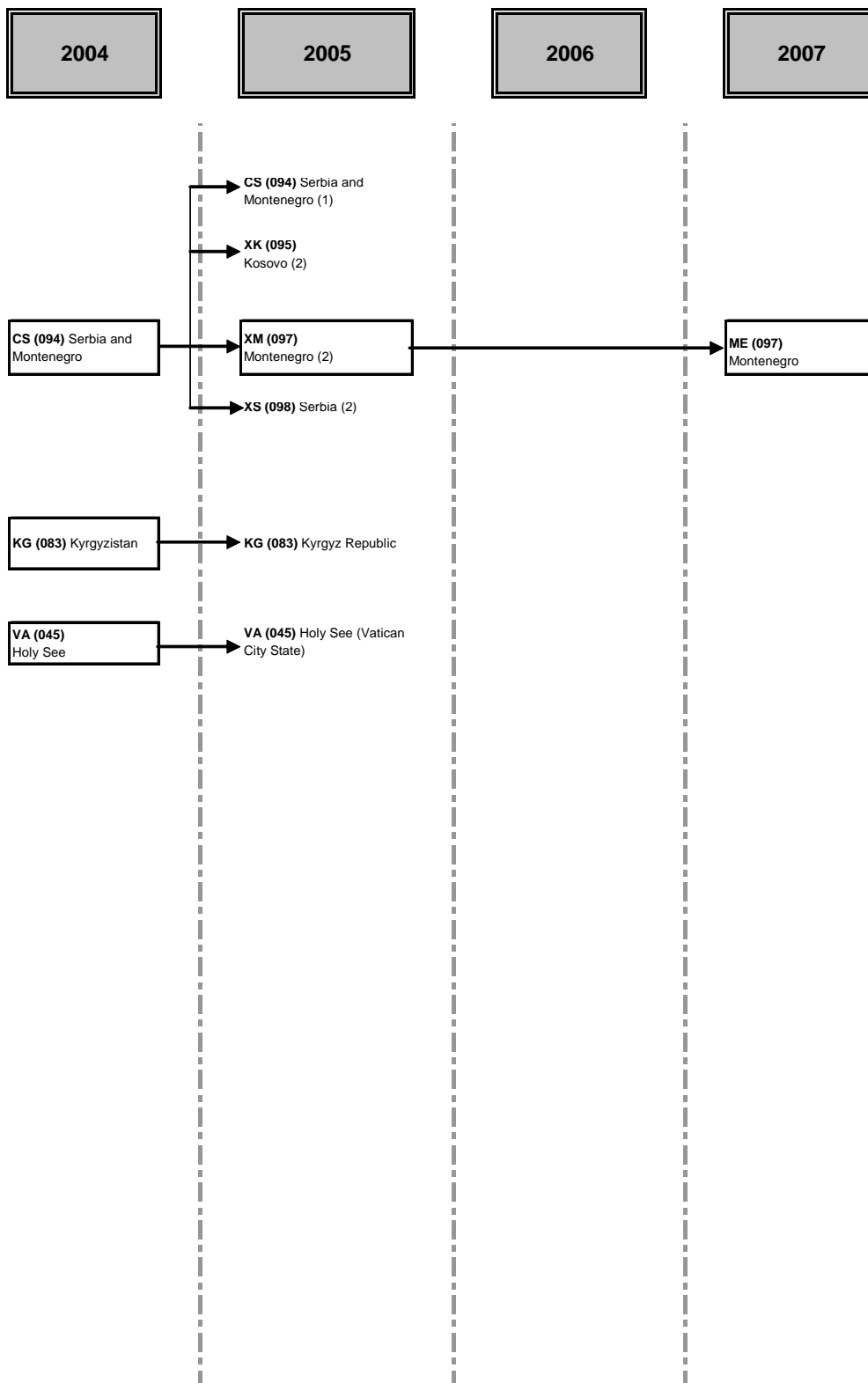

(1) Until 31.5.2005

(2) From 1.6.2005



CORRESPONDENCE CODES-ZONES

Code		Text	Economic zones	Geographical zones
ISO	GEO			
1	2	3	4	5
AD	(043)	Andorra	1011,1014,1118,1811,1812,1813,1814,1816,1817	5100,5190
AE	(647)	United Arab Emirates	1011,1014,1053,1118,1811,1812,1813,1814,1816,1817	5400,5410
AF	(660)	Afghanistan	1011,1014,1059,1118,1430,1811,1812,1813,1814,1816,1817	5400,5490
AG	(459)	Antigua and Barbuda	1011,1014,1031,1118,1811,1812,1813,1814,1816,1817	5300,5320
AI	(446)	Anguilla	1011,1014,1118,1811,1812,1813,1814,1816,1817	5300,5320
AL	(070)	Albania	1011,1014,1051,1055,1118,1120,1811,1812,1813,1814,1816,1817	5100,5190
AM	(077)	Armenia	1011,1014,1118,1811,1812,1813,1814,1815,1816,1817	5400,5410
AN	(478)	Netherlands Antilles	1011,1014,1118,1811,1812,1813,1814,1816,1817	5300,5320
AO	(330)	Angola	1011,1014,1031,1053,1118,1430,1811,1812,1813,1814,1816,1817	5200,5290
AQ	(891)	Antarctica	1011,1014,1118,1811,1812,1813,1814,1816,1817	5500,5590
AR	(528)	Argentina	1011,1014,1058,1118,1330,1811,1812,1813,1814,1816,1817	5300,5330
AS	(830)	American Samoa	1011,1014,1118,1811,1812,1813,1814,1816,1817	5500,5590
AT	(038)	Austria	1010,1013,1110,1111,1112,1113,1114,1115,1116,1117	5100,5110
AU	(800)	Australia	1011,1014,1118,1420,1811,1812,1813,1814,1816,1817,1820	5500,5510
AW	(474)	Aruba	1011,1014,1118,1811,1812,1813,1814,1816,1817	5300,5320
AZ	(078)	Azerbaijan	1011,1014,1118,1811,1812,1813,1814,1815,1816,1817	5400,5410
BA	(093)	Bosnia and Herzegovina	1011,1014,1051,1055,1118,1120,1811,1812,1813,1814,1816,1817	5100,5190
BB	(469)	Barbados	1011,1014,1031,1118,1811,1812,1813,1814,1816,1817	5300,5320
BD	(666)	Bangladesh	1011,1014,1059,1118,1430,1811,1812,1813,1814,1816,1817	5400,5490
BE	(017)	Belgium	1010,1013,1110,1111,1112,1113,1114,1115,1116,1117	5100,5110
BF	(236)	Burkina Faso	1011,1014,1031,1118,1430,1811,1812,1813,1814,1816,1817	5200,5290
BG	(068)	Bulgaria	1010,1011,1014,1112,1118,1811,1813,1816,1817	5100,5110

Code		Text	Economic zones	Geographical zones
ISO	GEO			
1	2	3	4	5
BH	(640)	Bahrain	1011,1014,1118,1811,1812,1813,1814,1816,1817	5400,5410
BI	(328)	Burundi	1011,1014,1031,1118,1430,1811,1812,1813,1814,1816,1817	5200,5290
BJ	(284)	Benin	1011,1014,1031,1118,1430,1811,1812,1813,1814,1816,1817	5200,5290
BM	(413)	Bermuda	1011,1014,1118,1811,1812,1813,1814,1816,1817	5300,5320
BN	(703)	Brunei Darussalam	1011,1014,1057,1118,1420,1811,1812,1813,1814,1816,1817	5400,5490
BO	(516)	Bolivia	1011,1014,1058,1118,1811,1812,1813,1814,1816,1817	5300,5330
BR	(508)	Brazil	1011,1014,1058,1118,1330,1811,1812,1813,1814,1816,1817	5300,5330
BS	(453)	Bahamas	1011,1014,1031,1118,1811,1812,1813,1814,1816,1817	5300,5320
BT	(675)	Bhutan	1011,1014,1059,1118,1430,1811,1812,1813,1814,1816,1817	5400,5490
BV	(892)	Bouvet Island	1011,1014,1118,1811,1812,1813,1814,1816,1817	5500,5590
BW	(391)	Botswana	1011,1014,1031,1118,1811,1812,1813,1814,1816,1817	5200,5290
BY	(073)	Belarus	1011,1014,1118,1811,1812,1813,1814,1815,1816,1817	5100,5190
BZ	(421)	Belize	1011,1014,1031,1118,1811,1812,1813,1814,1816,1817	5300,5320
CA	(404)	Canada	1011,1014,1118,1310,1420,1811,1812,1813,1814,1816,1817,1820	5300,5310
CC	(833)	Cocos Islands (or Keeling Islands)	1011,1014,1118,1811,1812,1813,1814,1816,1817-1820	5500,5510
CD	(322)	Congo, Democratic Republic of	1011,1014,1031,1118,1430,1811,1812,1813,1814,1816,1817	5200,5290
CF	(306)	Central African Republic	1011,1014,1031,1118,1430,1811,1812,1813,1814,1816,1817	5200,5290
CG	(318)	Congo	1011,1014,1031,1118,1811,1812,1813,1814,1816,1817	5200,5290
CH	(039)	Switzerland	1011,1014,1021,1118,1811,1812,1813,1814,1816,1817,1820	5100,5190
CI	(272)	Côte d'Ivoire	1011,1014,1031,1118,1811,1812,1813,1814,1816,1817	5200,5290
CK	(837)	Cook Islands	1011,1014,1031,1118,1811,1812,1813,1814,1816,1817	5500,5510

Code		Text	Economic zones	Geographical zones
ISO	GEO			
1	2	3	4	5
CL	(512)	Chile	1011,1014,1058,1118,1420,1811,1812,1813,1814,1816,1817	5300,5330
CM	(302)	Cameroon	1011,1014,1031,1118,1811,1812,1813,1814,1816,1817	5200,5290
CN	(720)	China	1011,1014,1118,1420,1811,1812,1813,1814,1816,1817	5400,5490
CO	(480)	Colombia	1011,1014,1058,1118,1811,1812,1813,1814,1816,1817	5300,5330,
CR	(436)	Costa Rica	1011,1014,1058,1118,1811,1812,1813,1814,1816,1817	5300,5320
CU	(448)	Cuba	1011,1014,1031,1058,1118,1811,1812,1813,1814,1816,1817	5300,5320
CV	(247)	Cape Verde	1011,1014,1031,1118,1811,1812,1813,1814,1816,1817	5200,5290
CX	(834)	Christmas Island	1011,1014,1118,1811,1812,1813,1814,1816,1817,1820	5500,5510
CY	(600)	Cyprus	1010,1013,1111,1112,1115,1116,1117,1811,1813,1816	5100,5110
CZ	(061)	Czech Republic	1010,1014,1111,1112,1115,1118,1811,1813,1816,1817	5100,5110
DE	(004)	Germany	1010,1013,1110,1111,1112,1113,1114,1115,1116,1117	5100,5110
DJ	(338)	Djibouti	1011,1014,1031,1430,1118,1811,1812,1813,1814,1816,1817	5200,5290
DK	(008)	Denmark	1010,1014,1110,1111,1112,1115,1118,1813,1816,1817	5100,5110
DM	(460)	Dominica	1011,1014,1031,1118,1811,1812,1813,1814,1816,1817	5300,5320
DO	(456)	Dominican Republic	1011,1014,1031,1058,1118,1811,1812,1813,1814,1816,1817	5300,5320
DZ	(208)	Algeria	1011,1014,1051,1053,1055,1118,1811,1812,1813,1814,1816,1817	5200,5210
EC	(500)	Ecuador	1011,1014,1053,1058,1118,1811,1812,1813,1814,1816,1817	5300,5330
EE	(053)	Estonia	1010,1014,1111,1112,1115,1118,1811,1813,1816,1817	5100,5110
EG	(220)	Egypt	1011,1014,1051,1055,1118,1811,1812,1813,1814,1816,1817	5200,5210
ER	(336)	Eritrea	1011,1014,1031,1430,1118,1811,1812,1813,1814,1816,1817	5200,5290
ES	(011)	Spain	1010,1013,1110,1111,1112,1113,1114,1115,1116,1117	5100,5110
ET	(334)	Ethiopia	1011,1014,1031,1430,1118,1811,1812,1813,1814,1816,1817	5200,5290

Code		Text	Economic zones	Geographical zones
ISO	GEO			
1	2	3	4	5
FI	(032)	Finland	1010,1013,1110,1111,1112,1113,1114,1115,1116,1117,1118	5100,5110
FJ	(815)	Fiji	1011,1014,1031,1118,1811,1812,1813,1814,1816,1817	5500,5590
FK	(529)	Falkland Islands	1011,1014,1118,1811,1812,1813,1814,1816,1817	5300,5330
FM	(823)	Micronesia, Federated States of	1011,1014,1031,1118,1811,1812,1813,1814,1816,1817	5500,5590
FO	(041)	Faroe Islands	1011,1014,1118,1811,1812,1813,1814,1816,1817	5100,5190
FR	(001)	France	1010,1013,1110,1111,1112,1113,1114,1115,1116,1117	5100,5110
GA	(314)	Gabon	1011,1014,1031,1118,1811,1812,1813,1814,1816,1817	5200,5290
GB	(006)	United Kingdom	1010,1014,1110,1111,1112,1115,1118,1813,1816,1817	5100,5110
GD	(473)	Grenada	1011,1014,1031,1118,1811,1812,1813,1814,1816,1817	5300,5320
GE	(076)	Georgia	1011,1014,1118,1811,1812,1813,1814,1816,1817	5400,5410
GH	(276)	Ghana	1011,1014,1031,1118,1811,1812,1813,1814,1816,1817	5200,5290
GI	(044)	Gibraltar	1011,1014,1051,1118,1811,1812,1813,1814,1816,1817	5100,5190
GL	(406)	Greenland	1011,1014,1118,1811,1812,1813,1814,1816,1817	5300,5310
GM	(252)	Gambia	1011,1014,1031,1118,1430,1811,1812,1813,1814,1816,1817	5200,5290
GN	(260)	Guinea	1011,1014,1031,1118,1430,1811,1812,1813,1814,1816,1817	5200,5290
GQ	(310)	Equatorial Guinea	1011,1014,1031,1118,1430,1811,1812,1813,1814,1816,1817	5200,5290
GR	(009)	Greece	1010,1013,1110,1111,1112,1113,1114,1115,1116,1117	5100,5110
GS	(893)	South Georgia and South Sandwich Islands	1011,1014,1118,1811,1812,1813,1814,1816,1817	5500,5590
GT	(416)	Guatemala	1011,1014,1058,1118,1811,1812,1813,1814,1816,1817	5300,5320
GU	(831)	Guam	1011,1014,1118,1811,1812,1813,1814,1816,1817	5500,5590
GW	(257)	Guinea-Bissau	1011,1014,1031,1118,1430,1811,1812,1813,1814,1816,1817	5200,5290
GY	(488)	Guyana	1011,1014,1031,1118,1811,1812,1813,1814,1816,1817	5300,5330
HK	(740)	Hong Kong	1011,1014,1118,1410,1415,1420,1811,1812,1813,1814,1816,1817	5400,5490

Code		Text	Economic zones	Geographical zones
ISO	GEO			
1	2	3	4	5
HM	(835)	Heard Island and McDonald Islands	1011,1014,1118,1811,1812,1813,1814,1816,1817,1820	5500,5510
HN	(424)	Honduras	1011,1014,1058,1118,1811,1812,1813,1814,1816,1817	5300,5320
HR	(092)	Croatia	1011,1014,1051,1055,1118,1120,1130,1811,1812,1813,1814,1816,1817	5100,5190
HT	(452)	Haiti	1011,1014,1031,1058,1118,1430,1811,1812,1813,1814,1816,1817	5300,5320
HU	(064)	Hungary	1010,1014,1111,1112,1115,1118,1811,1813,1816,1817	5100,5110
ID	(700)	Indonesia	1011,1014,1057,1118,1420,1811,1812,1813,1814,1816,1817	5400,5490
IE	(007)	Ireland	1010,1013,1110,1111,1112,1113,1114,1115,1116,1117	5100,5110
IL	(624)	Israel	1011,1014,1051,1055,1118,1811,1812,1813,1814,1816,1817	5400,5410
IN	(664)	India	1011,1014,1059,1118,1811,1812,1813,1814,1816,1817	5400,5490
IO	(357)	British Indian Ocean Territory	1011,1014,1118,1811,1812,1813,1814,1816,1817	5200,5290
IQ	(612)	Iraq	1011,1014,1053,1118,1811,1812,1813,1814,1816,1817	5400,5410
IR	(616)	Iran, Islamic Republic of	1011,1014,1053,1118,1811,1812,1813,1814,1816,1817	5400,5410
IS	(024)	Iceland	1011,1014,1021,1115,1118,1811,1812,1813,1814,1816,1817,1820	5100,5190
IT	(005)	Italy	1010,1013,1110,1111,1112,1113,1114,1115,1116,1117	5100,5110
JM	(464)	Jamaika	1011,1014,1031,1118,1811,1812,1813,1814,1816,1817	5300,5320
JO	(628)	Jordan	1011,1014,1051,1055,1118,1811,1812,1813,1814,1816,1817	5400,5410
JP	(732)	Japan	1011,1014,1420,1118,1811,1812,1813,1814,1816,1817,1820	5400,5490
KE	(346)	Kenya	1011,1014,1031,1118,1811,1812,1813,1814,1816,1817	5200,5290
KG	(083)	Kirgyz, Republic	1011,1014,1118,1811,1812,1813,1814,1815,1816,1817	5400,5490
KH	(696)	Cambodia	1011,1014,1057,1118,1430,1811,1812,1813,1814,1816,1817	5400,5490
KI	(812)	Kiribati	1011,1014,1031,1118,1430,1811,1812,1813,1814,1816,1817	5500,5590

Code		Text	Economic zones	Geographical zones
ISO	GEO			
1	2	3	4	5
KM	(375)	Comoros	1011,1014,1031,1118,1430,1811,1812,1813,1814,1816,1817	5200,5290
KN	(449)	St Kitts and Nevis	1011,1014,1031,1118,1811,1812,1813,1814,1816,1817	5300,5320
KP	(724)	Korea, Democratic People's Republic of	1011,1014,1118,1811,1812,1813,1814,1816,1817	5400,5490
KR	(728)	Korea, Republic of	1011,1014,1118,1410,1415,1420,1811,1812,1813,1814,1816,1817,1820	5400,5490
KW	(636)	Kuwait	1011,1014,1053,1118,1811,1812,1813,1814,1816,1817	5400,5410
KY	(463)	Cayman Islands	1011,1014,1118,1811,1812,1813,1814,1816,1817	5300,5320
KZ	(079)	Kazakhstan	1011,1014,1118,1811,1812,1813,1814,1815,1816,1817	5400,5490
LA	(684)	Lao People's Democratic Republic	1011,1014,1057,1118,1430,1811,1812,1813,1814,1816,1817	5400,5490
LB	(604)	Lebanon	1011,1014,1051,1055,1118,1811,1812,1813,1814,1816,1817	5400,5410
LC	(465)	St Lucia	1011,1014,1031,1118,1811,1812,1813,1814,1816,1817	5300,5320
LI	(037)	Liechtenstein	1011,1014,1021,1115,1118,1811,1812,1813,1814,1816,1817	5100,5190
LK	(669)	Sri Lanka	1011,1014,1059,1118,1811,1812,1813,1814,1816,1817	5400,5490
LR	(268)	Liberia	1011,1014,1031,1118,1430,1811,1812,1813,1814,1816,1817	5200,5290
LS	(395)	Lesotho	1011,1014,1031,1118,1430,1811,1812,1813,1814,1816,1817	5200,5290
LT	(055)	Lithuania	1010,1014,1111,1112,1115,1118,1811,1813,1816,1817	5100,5110
LU	(018)	Luxembourg	1010,1013,1110,1112,1113,1114,1115,1116,1117	5100,5110
LV	(054)	Latvia	1010,1014,1111,1112,1115,1118,1811,1813,1816,1817	5100,5110
LY	(216)	Libyan Arab Jamahiriya	1011,1014,1051,1053,1118,1811,1812,1813,1814,1816,1817	5200,5210
MA	(204)	Morocco	1011,1014,1051,1055,1118,1811,1812,1813,1814,1816,1817	5200,5210
MD	(074)	Moldova, Republic of	1011,1014,1118,1811,1812,1813,1814,1815,1816,1817	5100,5190
ME	(097)	Montenegro	1011,1014,1051,1055,1118,1120,1811,1812,1813,1814,1816,1817	5100,5190

Code		Text	Economic zones	Geographical zones
ISO	GEO			
1	2	3	4	5
MG	(370)	Madagascar	1011,1014,1031,1118,1430,1811,1812,1813,1814,1816,1817	5200,5290
MH	(824)	Marshall Islands	1011,1014,1031,1118,1811,1812,1813,1814,1816,1817	5500,5590
MK	(096)	Former Yugoslav Republic of Macedonia	1011,1014,1051,1118,1120,1130,1811,1812,1813,1814,1816,1817	5100,5190
ML	(232)	Mali	1011,1014,1031,1118,1430,1811,1812,1813,1814,1816,1817	5200,5290
MM	(676)	Myanmar	1011,1014,1057,1118,1430,1811,1812,1813,1814,1816,1817	5400,5490
MN	(716)	Mongolia	1011,1014,1118,1811,1812,1813,1814,1816,1817	5400,5490
MO	(743)	Macao	1011,1014,1118,1811,1812,1813,1814,1816,1817	5400,5490
MP	(820)	Northern Mariana Islands	1011,1014,1118,1811,1812,1813,1814,1816,1817	5500,5590
MR	(228)	Mauritania	1011,1014,1031,1055,1118,1430,1811,1812,1813,1814,1816,1817	5200,5290
MS	(470)	Montserrat	1011,1014,1118,1811,1812,1813,1814,1816,1817	5300,5320
MT	(046)	Malta	1010,1013,1111,1112,1115,1116,1117,1811,1813,1816	5100,5110
MU	(373)	Mauritius	1011,1014,1031,1118,1811,1812,1813,1814,1816,1817	5200,5290
MV	(667)	Maldives	1011,1014,1059,1118,1430,1811,1812,1813,1814,1816,1817	5400,5490
MW	(386)	Malawi	1011,1014,1031,1118,1430,1811,1812,1813,1814,1816,1817	5200,5290
MX	(412)	Mexico	1011,1014,1058,1118,1310,1420,1811,1812,1813,1814,1816,1817,1820	5300,5320
MY	(701)	Malaysia	1011,1014,1057,1118,1415,1420,1811,1812,1813,1814,1816,1817	5400,5490
MZ	(366)	Mozambique	1011,1014,1031,1118,1430,1811,1812,1813,1814,1816,1817	5200,5290
NA	(389)	Namibia	1011,1014,1031,1118,1811,1812,1813,1814,1816,1817	5200,5290
NC	(809)	New Caledonia	1011,1014,1118,1811,1812,1813,1814,1816,1817	5500,5590
NE	(240)	Niger	1011,1014,1031,1118,1430,1811,1812,1813,1814,1816,1817	5200,5290
NF	(836)	Norfolk Island	1011,1014,1118,1811,1812,1813,1814,1816,1817,1820	5500,5510

Code		Text	Economic zones	Geographical zones
ISO	GEO			
1	2	3	4	5
NG	(288)	Nigeria	1011,1014,1031,1053,1118,1811,1812,1813,1814,1816,1817	5200,5290
NI	(432)	Nicaragua	1011,1014,1058,1118,1811,1812,1813,1814,1816,1817	5300,5320
NL	(003)	Netherlands	1010,1013,1110,1111,1113,1114,1115,1116,1117	5100,5110
NO	(028)	Norway	1011,1014,1021,1115,1118,1811,1812,1813,1814,1816,1817,1820	5100,5190
NP	(672)	Nepal	1011,1014,1059,1118,1430,1811,1812,1813,1814,1816,1817	5400,5490
NR	(803)	Nauru	1011,1014,1031,1118,1811,1812,1813,1814,1816,1817	5500,5590
NU	(838)	Niue	1011,1014,1031,1118,1811,1812,1813,1814,1816,1817	5500,5510
NZ	(804)	New Zealand	1011,1014,1118,1420,1811,1812,1813,1814,1816,1817,1820	5500,5510
OM	(649)	Oman	1011,1014,1118,1811,1812,1813,1814,1816,1817	5400,5410
PA	(442)	Panama	1011,1014,1058,1118,1811,1812,1813,1814,1816,1817	5300,5320
PE	(504)	Peru	1011,1014,1058,1118,1420,1811,1812,1813,1814,1816,1817	5300,5330
PF	(822)	French Polynesia	1011,1014,1118,1811,1812,1813,1814,1816,1817	5500,5590
PG	(801)	Papua New Guinea	1011,1014,1031,1118,1420,1811,1812,1813,1814,1816,1817	5500,5590
PH	(708)	Philippines	1011,1014,1057,1118,1420,1811,1812,1813,1814,1816,1817	5400,5490
PK	(662)	Pakistan	1011,1014,1059,1118,1811,1812,1813,1814,1816,1817	5400,5490
PL	(060)	Poland	1010,1014,1111,1112,1115,1118,1811,1813,1816,1817	5100,5110
PM	(408)	Saint Pierre and Miquelon	1011,1014,1118,1811,1812,1813,1814,1816,1817	5300,5310
PN	(813)	Pitcairn	1011,1014,1118,1811,1812,1813,1814,1816,1817	5500,5590
PS	(625)	Occupied Palestinian Territory	1011,1014,1051,1055,1118,1811,1812,1813,1814,1816,1817	5400,5410
PT	(010)	Portugal	1010,1013,1110,1111,1112,1113,1114,1115,1116,1117	5100,5110
PW	(825)	Palau	1011,1014,1031,1118,1811,1812,1813,1814,1816,1817	5500,5590
PY	(520)	Paraguay	1011,1014,1058,1118,1330,1811,1812,1813,1814,1816,1817	5300,5330

Code		Text	Economic zones	Geographical zones
ISO	GEO			
1	2	3	4	5
QA	(644)	Qatar	1011,1014,1053,1118,1811,1812,1813,1814,1816,1817	5400,5410
QQ	(950)	Stores and provisions	1090,1811,1812,1813	5900,5990
QR	(951)	Stores and provisions within the framework of intra-Community trade	1010,1013,1090,1091,1110,1111,1112,1113,1114,1115,1116,1117	5100,5110,5900,5910
QS	(952)	Stores and provisions within the framework of trade with third countries	1011,1014,1090,1092,1118,1811,1812,1813,1814,1816,1817	5900,5920
QU	(958)	Countries and territories not specified	1011,1090,1811,1812,1813	5900,5990
QV	(959)	Countries and territories not specified in the framework of intra-Community trade	1010,1013,1090,1091,1110,1111,1112,1113,1114,1115,1116,1117	5100,5110,5900,5910
QW	(960)	Countries and territories not specified in the framework of trade with third countries	1011,1014,1090,1092,1118,1811,1812,1813,1814,1816,1817	5900,5920
QX	(977)	Countries and territories not specified for commercial or military reasons	1090,1811,1812,1813	5900,5990
QY	(978)	Countries and territories not specified for commercial or military reasons in the framework of intra-Community trade	1010,1013,1090,1091,1110,1111,1112,1113,1114,1115,1116,1117	5100,5110,5900,5910
QZ	(979)	Countries and territories not specified for commercial or military reasons in the framework of trade with third countries	1011,1014,1090,1092,1118,1811,1812,1813,1814,1816,1817	5900,5920
RO	(066)	Romania	1010,1011,1014,1112,1118,1811,1813,1816,1817	5100,5110
RU	(075)	Russian Federation	1011,1014,1118,1420,1811,1812,1813,1814,1815,1816,1817	5100,5190
RW	(324)	Rwanda	1011,1014,1031,1118,1430,1811,1812,1813,1814,1816,1817	5200,5290
SA	(632)	Saudi Arabia	1011,1014,1053,1118,1811,1812,1813,1814,1816,1817	5400,5410
SB	(806)	Solomon Islands	1011,1014,1031,1118,1430,1811,1812,1813,1814,1816,1817	5500,5590
SC	(355)	Seychelles	1011,1014,1031,1118,1811,1812,1813,1814,1816,1817	5200,5290
SD	(224)	Sudan	1011,1014,1031,1118,1430,1811,1812,1813,1814,1816,1817	5200,5290
SE	(030)	Sweden	1010,1014,1110,1111,1112,1115,1118,1813,1816,1817	5100,5110
SG	(706)	Singapore	1011,1014,1057,1118,1410,1415,1420,1811,1812,1813,1814,1816,1817	5400,5490

Code		Text	Economic zones	Geographical zones
ISO	GEO			
1	2	3	4	5
SH	(329)	Saint Helena	1011,1014,1118,1811,1812,1813,1814,1816,1817	5200,5290
SI	(091)	Slovenia	1010,1013,1111,1112,1114,1115,1116,1117,1811,1813	5100,5110
SK	(063)	Slovakia	1010,1013,1111,1112,1115,1117,1811,1813,1816,1817	5100,5110
SL	(264)	Sierra Leone	1011,1014,1031,1118,1811,1812,1813,1814,1816,1817	5200,5290
SM	(047)	San Marino	1011,1014,1118,1811,1812,1813,1814,1816,1817	5100,5190
SN	(248)	Senegal	1011,1014,1031,1118,1430,1811,1812,1813,1814,1816,1817	5200,5290
SO	(342)	Somalia	1011,1014,1031,1118,1430,1811,1812,1813,1814,1816,1817	5200,5290
SR	(492)	Suriname	1011,1014,1031,1118,1811,1812,1813,1814,1816,1817	5300,5330
ST	(311)	Sao Tome and Principe	1011,1014,1031,1118,1430,1811,1812,1813,1814,1816,1817	5200,5290
SV	(428)	El Salvador	1011,1014,1058,1118,1811,1812,1813,1814,1816,1817	5300,5320
SY	(608)	Syrian Arab Republic	1011,1014,1051,1055,1118,1811,1812,1813,1814,1816,1817	5400,5410
SZ	(393)	Swaziland	1011,1014,1031,1118,1811,1812,1813,1814,1816,1817	5200,5290
TC	(454)	Turks and Caicos Islands	1011,1014,1118,1811,1812,1813,1814,1816,1817	5300,5320
TD	(244)	Chad	1011,1014,1031,1118,1430,1811,1812,1813,1814,1816,1817	5200,5290
TF	(894)	French Southern Territories	1011,1014,1118,1811,1812,1813,1814,1816,1817	5500,5590
TG	(280)	Togo	1011,1014,1031,1118,1430,1811,1812,1813,1814,1816,1817	5200,5290
TH	(680)	Thailand	1011,1014,1057,1118,1415,1420,1811,1812,1813,1814,1816,1817	5400,5490
TJ	(082)	Tajikistan	1011,1014,1118,1811,1812,1813,1814,1815,1816,1817	5400,5490
TK	(839)	Tokelau	1011,1014,1118,1811,1812,1813,1814,1816,1817	5500,5510
TL	(626)	Timor-Leste	1011,1014,1031,1118,1430,1811,1812,1813,1814,1816,1817	5400,5490
TM	(080)	Turkmenistan	1011,1014,1118,1811,1812,1813,1814,1815,1816,1817	5400,5490
TN	(212)	Tunisia	1011,1014,1051,1055,1118,1811,1812,1813,1814,1816,1817	5200,5210

Code		Text	Economic zones	Geographical zones
ISO	GEO			
1	2	3	4	5
TO	(817)	Tonga	1011,1014,1031,1118,1811,1812,1813,1814,1816,1817	5500,5590
TR	(052)	Turkey	1011,1014,1051,1055,1118,1130,1811,1812,1813,1814,1816,1817,1820	5100,5190
TT	(472)	Trinidad and Tobago	1011,1014,1031,1118,1811,1812,1813,1814,1816,1817	5300,5320
TV	(807)	Tuvalu	1011,1014,1031,1118,1430,1811,1812,1813,1814,1816,1817	5500,5590
TW	(736)	Taiwan	1011,1014,1118,1410,1415,1420,1811,1812,1813,1814,1816,1817	5400,5490
TZ	(352)	Tanzania, United Republic of	1011,1014,1031,1118,1430,1811,1812,1813,1814,1816,1817	5200,5290
UA	(072)	Ukraine	1011,1014,1118,1811,1812,1813,1814,1815,1816,1817	5100,5190
UG	(350)	Uganda	1011,1014,1031,1118,1430,1811,1812,1813,1814,1816,1817	5200,5290
UM	(832)	United States Minor Outlying Islands	1011,1014,1118,1811,1812,1813,1814,1816,1817	5500,5590
US	(400)	United States	1011,1014,1118,1310,1420,1811,1812,1813,1814,1816,1817,1820	5300,5310
UY	(524)	Uruguay	1011,1014,1058,1118,1330,1811,1812,1813,1814,1816,1817	5300,5330
UZ	(081)	Uzbekistan	1011,1014,1118,1811,1812,1813,1814,1815,1816,1817	5400,5490
VA	(045)	Holy See (Vatican City State)	1011,1014,1118,1811,1812,1813,1814,1817	5100,5190
VC	(467)	St Vincent and the Grenadines	1011,1014,1031,1118,1811,1812,1813,1814,1816,1817	5300,5320
VE	(484)	Venezuela	1011,1014,1053,1058,1118,1811,1812,1813,1814,1816,1817	5300,5330
VG	(468)	Virgin Islands, British	1011,1014,1118,1811,1812,1813,1814,1816,1817	5300,5320
VI	(457)	Virgin Islands (US)	1011,1014,1118,1811,1812,1813,1814,1816,1817,1820	5300,5320
VN	(690)	Viet-Nam	1011,1014,1057,1118,1420,1811,1812,1813,1814,1816,1817	5400,5490
VU	(816)	Vanuatu	1011,1014,1031,1118,1430,1811,1812,1813,1814,1816,1817	5500,5590
WF	(811)	Wallis and Futuna	1011,1014,1118,1811,1812,1813,1814,1816,1817	5500,5590
WS	(819)	Samoa	1011,1014,1031,1118,1430,1811,1812,1813,1814,1816,1817	5500,5590

Code		Text	Economic zones	Geographical zones
ISO	GEO			
1	2	3	4	5
XC	(021)	Ceuta	1011,1014,1051,1118,1811,1812,1813,1814,1816,1817	5200,5210
XK	(095)	Kosovo	1011,1014,1051,1118,1120,1811,1812,1813,1814,1816,1817	5100,5190
XL	(023)	Melilla	1011,1014,1051,1118,1811,1812,1813,1814,1816,1817	5200,5210
XS	(098)	Serbia	1011,1014,1051,1118,1120,1811,1812,1813,1814,1816,1817	5100,5190
YE	(653)	Yemen	1011,1014,1118,1430,1811,1812,1813,1814,1816,1817	5400,5410
YT	(377)	Mayotte	1011,1014,1118,1811,1812,1813,1814,1816,1817	5200,5290
ZA	(388)	South Africa	1011,1014,1031,1118,1811,1812,1813,1814,1816,1817	5200,5290
ZM	(378)	Zambia	1011,1014,1031,1118,1430,1811,1812,1813,1814,1816,1817	5200,5290
ZW	(382)	Zimbabwe	1011,1014,1031,1118,1811,1812,1813,1814,1816,1817	5200,5290



**CORRESPONDENCE
ISO 3166 CODES - EU CODES**

Note	ALPHA ISO	NUM ISO	ALPHA EU	NUM EU	COUNTRY	DESCRIPTION
*	AD	020	AD	043	Andorra	
*	AE	784	AE	647	United Arab Emirates	Abu Dhabi, Dubai, Sharjah, Ajman, Umm al Qaiwain, Ras al Khaima and Fujairah
*	AF	004	AF	660	Afghanistan	
*	AG	028	AG	459	Antigua and Barbuda	
*	AI	660	AI	446	Anguilla	
*	AL	008	AL	070	Albania	
*	AM	051	AM	077	Armenia	
*	AN	530	AN	478	Netherlands Antilles	Curaçao, Bonaire, St Eustatius, Saba and southern part of St Martin
*	AO	024	AO	330	Angola	Including Cabinda
*	AQ	010	AQ	891	Antarctica	Territory south of 60° south latitude; not including the French Southern Territories (TF), Bouvet Island (BV), South Georgia and South Sandwich Island (GS)
*	AR	032	AR	528	Argentina	
*	AS	016	AS	830	American Samoa	
*	AT	040	AT	038	Austria	
*	AU	036	AU	800	Australia	
*	AW	533	AW	474	Aruba	
*	AZ	031	AZ	078	Azerbaijan	
*	BA	070	BA	093	Bosnia and Herzegovina	
*	BB	052	BB	469	Barbados	
*	BD	050	BD	666	Bangladesh	
*	BE	056	BE	017	Belgium	
*	BF	854	BF	236	Burkina Faso	
*	BG	100	BG	068	Bulgaria	
*	BH	048	BH	640	Bahrain	
*	BI	108	BI	328	Burundi	
*	BJ	204	BJ	284	Benin	
*	BM	060	BM	413	Bermuda	
*	BN	096	BN	703	Brunei Darussalam	Often referred to as Brunei
*	BO	068	BO	516	Bolivia	
*	BR	076	BR	508	Brazil	
*	BS	044	BS	453	Bahamas	
*	BT	064	BT	675	Bhutan	
*	BV	074	BV	892	Bouvet Island	
*	BW	072	BW	391	Botswana	
*	BY	112	BY	073	Belarus	Often referred to as Belorussia
*	BZ	084	BZ	421	Belize	
*	CA	124	CA	404	Canada	
*	CC	166	CC	833	Cocos (Keeling), Islands	
*	CD	180	CD	322	Congo (Dem. Rep. of)	Formerly Zaire
*	CF	140	CF	306	Central African Republic	
*	CG	178	CG	318	Congo	
*	CH	756	CH	039	Switzerland	Including the German territory of Büsingen and the Italian municipality of Campione d'Italia Often referred to as Ivory Coast
*	CI	384	CI	272	Côte d'Ivoire	
*	CK	184	CK	837	Cook Islands	
*	CL	152	CL	512	Chile	
*	CM	120	CM	302	Cameroon	
*	CN	156	CN	720	China	
*	CO	170	CO	480	Colombia	
*	CR	188	CR	436	Costa Rica	
*	CU	192	CU	448	Cuba	
*	CV	132	CV	247	Cape-Verde	
*	CX	162	CX	834	Christmas Islands	
*	CY	196	CY	600	Cyprus	
*	CZ	203	CZ	061	Czech Republic	

Note	ALPHA ISO	NUM ISO	ALPHA EU	NUM EU	COUNTRY	DESCRIPTION
*	DE	276	DE	004	Germany	Including the island of Heligoland; excluding the territory of Büsingen
*	DJ	262	DJ	338	Djibouti	
*	DK	208	DK	008	Denmark	
*	DM	212	DM	460	Dominica	
*	DO	214	DO	456	Dominican Republic	
*	DZ	012	DZ	208	Algeria	
*	EC	218	EC	500	Ecuador	Including Galapagos Islands
*	EE	233	EE	053	Estonia	
*	EG	818	EG	220	Egypt	
*	ER	232	ER	336	Eritrea	
*	ES	724	ES	011	Spain	Including Balearic islands and Canary Islands; excluding Ceuta and Melilla
+	ES	724	XC	021	Ceuta	
+	ES	724	XL	023	Melilla	Including Peñón de Vélez de la Gomera, Peñón de Alhucemas and Chafarinas Islands
*	ET	231	ET	334	Ethiopia	
**	FI + AX	246 + 248	FI	032	Finland	Including Åland Islands
*	FJ	242	FJ	815	Fiji	
*	FK	238	FK	529	Falkland Islands (Malvinas)	
*	FM	583	FM	823	Micronesia, Federated States of	Chuuk, Kosrae, Pohnpei and Yap.
*	FO	234	FO	041	Faroe Islands	
**	FR+BL+ GF+GP+ MC+MF+ MQ+RE	250+254+ 312+474+ 492+638+ 652+663	FR	001	France	Including Monaco and the French overseas departments (Réunion, Guadeloupe, Martinique, French Guiana, Saint Barthelemy and Saint Martin)
*	GA	266	GA	314	Gabon	
**	GB+GG+ IM+JE	826+831+ 832+833	GB	006	United Kingdom	Great Britain, Northern Ireland, Channel Islands and Isle of Man
*	GD	308	GD	473	Grenada	Including southern Grenadines
*	GE	268	GE	076	Georgia	
*	GH	288	GH	276	Ghana	
*	GI	292	GI	044	Gibraltar	
*	GL	304	GL	406	Greenland	
*	GM	270	GM	252	Gambia	
*	GN	324	GN	260	Guinea	
*	GQ	226	GQ	310	Equatorial Guinea	
*	GR	300	GR	009	Greece	
*	GS	239	GS	893	South Georgia and South Sandwich Islands	
*	GT	320	GT	416	Guatemala	
*	GU	316	GU	831	Guam	
*	GW	624	GW	257	Guinea-Bissau	
*	GY	328	GY	488	Guyana	
*	HK	344	HK	740	Hong Kong	Hong Kong Special Administrative Region of China.
*	HM	334	HM	835	Heard Island and McDonald Islands	
*	HN	340	HN	424	Honduras	Including Swan Islands
*	HR	191	HR	092	Croatia	
*	HT	332	HT	452	Haiti	
*	HU	348	HU	064	Hungary	
*	ID	360	ID	700	Indonesia	
*	IE	372	IE	007	Ireland	
*	IL	376	IL	624	Israel	
*	IN	356	IN	664	India	
*	IO	086	IO	357	British Indian Ocean Territory	Chagos Archipelago
*	IQ	368	IQ	612	Iraq	
*	IR	364	IR	616	Iran, Islamic Republic of	
*	IS	352	IS	024	Iceland	
*	IT	380	IT	005	Italy	Including Livigno; excluding the municipality of Campione d'Italia

Note	ALPHA ISO	NUM ISO	ALPHA EU	NUM EU	COUNTRY	DESCRIPTION
*	JM	388	JM	464	Jamaica	
*	JO	400	JO	628	Jordan	
*	JP	392	JP	732	Japan	
*	KE	404	KE	346	Kenya	
*	KG	417	KG	083	Kyrgyzstan	
*	KH	116	KH	696	Cambodia	
*	KI	296	KI	812	Kiribati	
*	KM	174	KM	375	Comoros	Anjouan, Grande Comore et Mohéli
*	KN	659	KN	449	St Kitts and Nevis	
*	KP	408	KP	724	Korea, Democratic People's Republic of	Often referred to as North Korea
*	KR	410	KR	728	Korea, Republic of	Often referred to as South Korea
*	KW	414	KW	636	Kuwait	
*	KY	136	KY	463	Cayman Islands	
*	KZ	398	KZ	079	Kazakhstan	
*	LA	418	LA	684	Lao People's Democratic Republic of	Often referred to as Laos
*	LB	422	LB	604	Lebanon	
*	LC	662	LC	465	Saint Lucia	
*	LI	438	LI	037	Liechtenstein	
*	LK	144	LK	669	Sri Lanka	
*	LR	430	LR	268	Liberia	
*	LS	426	LS	395	Lesotho	
*	LT	440	LT	055	Lithuania	
*	LU	442	LU	018	Luxembourg	
*	LV	428	LV	054	Latvia	
*	LY	434	LY	216	Libyan Arab Jamahiriya	Often referred to as Libya
*	MA	504	MA	204	Morocco	
*	MD	498	MD	074	Moldova, Republic of	
+	ME	499	ME	097	Montenegro	
*	MG	450	MG	370	Madagascar	
*	MH	584	MH	824	Marshall Islands	
*	MK	807	MK	096	Macedonia, Former Yugoslav Republic of	
*	ML	466	ML	232	Mali	
*	MM	104	MM	676	Myanmar	Often referred to as Burma
*	MN	496	MN	716	Mongolia	
*	MO	446	MO	743	Macao	Special Administrative Region of China
*	MP	580	MP	820	Northern Mariana Islands	
*	MR	478	MR	228	Mauritania	
*	MS	500	MS	470	Montserrat	
*	MT	470	MT	046	Malta	Including Gozo and Comino
*	MU	480	MU	373	Mauritius	Mauritius, Rodrigues Island, Agalega Islands and Cargados Carajos Shoals (St Brandon Islands)
*	MV	462	MV	667	Maldives	
*	MW	454	MW	386	Malawi	
*	MX	484	MX	412	Mexico	
*	MY	458	MY	701	Malaysia	Peninsular Malaysia and Eastern Malaysia (Sarawak, Sabah and Labuan)
*	MZ	508	MZ	366	Mozambique	
*	NA	516	NA	389	Namibia	
*	NC	540	NC	809	New Caledonia	Including Loyalty Islands (Lifou, Maré and Ouvéa)
*	NE	562	NE	240	Niger	
*	NF	574	NF	836	Norfolk Island	
*	NG	566	NG	288	Nigeria	
*	NI	558	NI	432	Nicaragua	Including Corn Islands
*	NL	528	NL	003	Netherlands	
**	NO+SJ	578+744	NO	028	Norway	Including Svalbard Archipelago and Jan Mayen Island
*	NP	524	NP	672	Nepal	
*	NR	520	NR	803	Nauru	
*	NU	570	NU	838	Niue	
*	NZ	554	NZ	804	New Zealand	Excluding Ross Dependency (Antarctica)

Note	ALPHA ISO	NUM ISO	ALPHA EU	NUM EU	COUNTRY	DESCRIPTION
*	OM	512	OM	649	Oman	
*	PA	591	PA	442	Panama	Including former Canal Zone
*	PE	604	PE	504	Peru	
*	PF	258	PF	822	French Polynesia	Marquesas, Society and Gambier Islands, Tubuai Islands and Tuamotu Archipelago; including Clipperton Island
*	PG	598	PG	801	Papua New Guinea	Including New Britain, New Ireland, Lavongai (New Hanover), Admiralty, Bougainville, Buka, Green, d'Entrecasteaux, Trobriand and Woodlark Islands and Louisiade Archipelago and their dependencies
*	PH	608	PH	708	Philippines	
*	PK	586	PK	662	Pakistan	
*	PL	616	PL	060	Poland	
*	PM	666	PM	408	Saint Pierre and Miquelon	
*	PN	612	PN	813	Pitcairn	Including Henderson, Ducie and Oeno Islands
*	PS	275	PS	625	Palestinian Territory, Occupied	West Bank (including East Jerusalem) and Gaza Strip
*	PT	620	PT	010	Portugal	Including Azores and Madeira
*	PW	585	PW	825	Palau	
*	PY	600	PY	520	Paraguay	
*	QA	634	QA	644	Qatar	
*	RO	642	RO	066	Romania	
+	RS	688	XK	095	Kosovo	As defined by United Nations Security Council Resolution 1244 of 10 June 1999.
+	RS	688	XS	098	Serbia	
*	RU	643	RU	075	Russian Federation	Often referred to as Russia
*	RW	646	RW	324	Rwanda	
*	SA	682	SA	632	Saudi Arabia	
*	SB	090	SB	806	Solomon Islands	
*	SC	690	SC	355	Seychelles	Mahé, Silhouette, Praslin (including La Digue), Frégate, Mamelles and Récifs, Bird and Denis, Plate and Coëtivy, Amirantes, Alphonse, Providence and Aldabra Islands
*	SD	736	SD	224	Sudan	
*	SE	752	SE	030	Sweden	
*	SG	702	SG	706	Singapore	
*	SH	654	SH	329	Saint Helena	Dependencies of St Helena: Ascension Island and Tristan da Cunha Islands
*	SI	705	SI	091	Slovenia	
*	SK	703	SK	063	Slovakia	
*	SL	694	SL	264	Sierra Leone	
*	SM	674	SM	047	San Marino	
*	SN	686	SN	248	Senegal	
*	SO	706	SO	342	Somalia	
*	SR	740	SR	492	Suriname	
*	ST	678	ST	311	Sao Tomé and Príncipe	
*	SV	222	SV	428	El Salvador	
*	SY	760	SY	608	Syrian Arab Republic	Often referred to as Syria
*	SZ	748	SZ	393	Swaziland	
*	TC	796	TC	454	Turks and Caicos Islands	
*	TD	148	TD	244	Chad	
*	TF	260	TF	894	French Southern Territories	Including Kerguelen Islands, Amsterdam Island, Saint-Paul Island, Crozet Archipelago
*	TG	768	TG	280	Togo	
*	TH	764	TH	680	Thailand	
*	TJ	762	TJ	082	Tajikistan	
*	TK	772	TK	839	Tokelau	
*	TL	626	TL	626	Timor-Leste	
*	TM	795	TM	080	Turkmenistan	
*	TN	788	TN	212	Tunisia	
*	TO	776	TO	817	Tonga	
*	TR	792	TR	052	Turkey	
*	TT	780	TT	472	Trinidad and Tobago	
*	TV	798	TV	807	Tuvalu	

Note	ALPHA ISO	NUM ISO	ALPHA EU	NUM EU	COUNTRY	DESCRIPTION
*	TW	158	TW	736	Taiwan	Separate customs territory of Taiwan, Penghu, Kinmen and Matsu.
*	TZ	834	TZ	352	Tanzania, United Republic of	Tanganyika, Zanzibar Island and Pemba
*	UA	804	UA	072	Ukraine	
*	UG	800	UG	350	Uganda	
*	UM	581	UM	832	United States Minor Outlying islands	Including Baker Island, Howland Island, Jarvis Island, Johnston Atoll, Kingman Reef, Midway Islands, Navassa Island, Palmyra Atoll and Wake Island
**	US+PR	840+630	US	400	United states	Including Puerto Rico
*	UY	858	UY	524	Uruguay	
*	UZ	860	UZ	081	Uzbekistan	
*	VA	336	VA	045	Holy See	Often referred to as Vatican City State
*	VC	670	VC	467	St Vincent and the Grenadines	
*	VE	862	VE	484	Venezuela	
*	VG	092	VG	468	Virgin Islands, British	
*	VI	850	VI	457	Virgin Islands (US)	
*	VN	704	VN	690	Viet-Nam	
*	VU	548	VU	816	Vanuatu	
*	WF	876	WF	811	Wallis and Futuna	Including Alofi
*	WS	882	WS	819	Samoa	Formerly known as Western Samoa
*	YE	887	YE	653	Yemen	Formerly North Yemen and South Yemen
*	YT	175	YT	377	Mayotte	Grande-Terre and Pamandzi
*	ZA	710	ZA	388	South Africa	
*	ZM	894	ZM	378	Zambia	
*	ZW	716	ZW	382	Zimbabwe	
>>>			EU	999	European Community	Code reserved, within the trade with non-members countries, for the declaration of the origin of goods according to the conditions laid down in the relevant Community provisions. Code not to be used for statistical purposes
>>>			QQ	950	Stores and provisions	Optional heading
>>>			QR	951	Stores and provisions within the framework of intra-Community trade	Optional heading
>>>			QS	952	Stores and provisions within the framework of trade with third Countries	Optional heading
>>>			QU	958	Countries and territories not specified	Optional heading
>>>			QV	959	Countries and territories not specified in the framework of intra-Community trade	Optional heading
>>>			QW	960	Countries and territories not specified within the framework of trade with third countries	Optional heading
>>>			QX	977	Countries and territories not specified for commercial or military reasons	Optional heading
>>>			QY	978	Countries and territories not specified for commercial or military reasons in the framework of intra-Community trade	Optional heading
>>>			QZ	979	Countries and territories not specified for commercial or military reasons in the framework of trade with third countries	Optional heading

Note	ALPHA ISO	NUM ISO	ALPHA EU	NUM EU	COUNTRY	DESCRIPTION
ISO 3166 codes included in EU codes						
**	AX	248	incl. FI	248	Åland Islands	
**	BL	652	incl. FR	001	Saint Barthelemy	
**	GF	254	incl. FR	001	French Guiana	
**	GG	831	incl. GB	006	Guemsey	
**	GP	312	incl. FR	001	Guadeloupe	
**	IM	833	incl. GB	006	Isle of Man	
**	JE	832	incl. GB	006	Jersey	
**	MC	492	incl. FR	001	Monaco	
**	MF	663	incl. FR	001	Saint Martin	
**	MQ	474	incl. FR	001	Martinique	
**	PR	630	incl. US	400	Puerto Rico	
**	RE	638	incl. FR	001	Réunion	
**	SJ	744	incl. NO	028	Svalbard & Jan Mayen Islands	

EU code not mentioned in ISO 3166

>>>			EU	999	European Community	Code reserved, within the trade with non-members countries, for the declaration of the origin of goods according to the conditions laid down in the relevant Community provisions. Code not to be used for statistical purposes
-----	--	--	----	-----	--------------------	---

Note

- * = Perfect correspondence
- + = Partial correspondence
- ** = Correspondence based on an aggregation of ISO 3166 codes
- >>> = No correspondence



ALPHABETICAL INDEX

A

<i>Abkhazia</i>	<i>Georgia</i>	GE (076)
<i>Abu Dhabi</i>	<i>United Arab Emirates</i>	AE (647)
<i>Adélie Land</i>	<i>Antarctica</i>	AQ (891)
<i>Adjara</i>	<i>Georgia</i>	GE (076)
<i>Admiralty Islands</i>	<i>Papua New Guinea</i>	PG (801)
Afghanistan		AF (660)
<i>Africa South</i>	<i>South Africa</i>	ZA (388)
<i>Agalega, Islands</i>	<i>Mauritius</i>	MU (373)
<i>Ahvenanmaa, Islands</i>	<i>Finland</i>	FI (032)
<i>Ajman</i>	<i>United Arab Emirates</i>	AE (647)
<i>Åland, Islands</i>	<i>Finland</i>	FI (032)
<i>Alaska</i>	<i>United States</i>	US (400)
Albania		AL (070)
<i>Aldabra, Islands</i>	<i>Seychelles</i>	SC (355)
<i>Alderney, Island</i>	<i>United Kingdom</i>	GB (006)
Algeria		DZ (208)
<i>Alofi, Island</i>	<i>Wallis and Futuna</i>	WF (811)
<i>Alphonse, Island</i>	<i>Seychelles</i>	SC (355)
<i>Ambergris Cay, Island</i>	<i>Belize</i>	BZ (421)
American Samoa		AS (830)
<i>Amindivi, Islands</i>	<i>India</i>	IN (664)
<i>Amirantes, Islands</i>	<i>Seychelles</i>	SC (355)
<i>Amsterdam, Island</i>	<i>French Southern Territories</i>	TF (894)
<i>Andaman, Islands</i>	<i>India</i>	IN (664)
Andorra		AD (043)
<i>Andros, Island</i>	<i>Bahamas</i>	BS (453)
<i>Anegada</i>	<i>Virgin Islands, British</i>	VG (468)
Angola		AO (330)
Anguilla		AI (446)
<i>Anjouan, Island</i>	<i>Comoros</i>	KM (375)
<i>Annobón, Island</i>	<i>Equatorial Guinea</i>	GQ (310)
<i>Antarctic, Australian Territory</i>	<i>Antarctica</i>	AQ (891)
<i>Antarctic, British Territory</i>	<i>Antarctica</i>	AQ (891)
<i>Antarctica, Peninsula</i>	<i>Antarctica</i>	AQ (891)
Antarctica		AQ (891)
Antigua and Barbuda		AG (459)
<i>Antilles, Netherlands</i>	<i>Netherlands Antilles</i>	AN (478)
<i>Antipodes, Islands</i>	<i>New Zealand</i>	NZ (804)
<i>Apolima, Island</i>	<i>Samoa</i>	WS (819)
<i>Arab, United - Emirates</i>	<i>United Arab Emirates</i>	AE (647)
<i>Archipelago des Bijagos</i>	<i>Guinea-Bissau</i>	GW (257)
<i>Archipelago Franz Joseph</i>	<i>Russian Federation</i>	RU (075)
<i>Archipelago, Bismarck</i>	<i>Papua New Guinea</i>	PG (801)
<i>Archipelago, Canadian Arctic</i>	<i>Canada</i>	CA (404)
<i>Archipelago, Chagos</i>	<i>British Indian Ocean Territory</i>	IO (357)
<i>Archipelago, Svalbard</i>	<i>Norway</i>	NO (028)
<i>Archipelago, Tuamotu</i>	<i>French Polynesia</i>	PF (822)
<i>Archipelago, Visayas</i>	<i>Philippines</i>	PH (708)
<i>Arctic archipelago, Canadian</i>	<i>Canada</i>	CA (404)
Argentina		AR (528)
<i>Arde, Island</i>	<i>Seychelles</i>	SC (355)
Armenia		AM (077)
Aruba		AW (474)
<i>Ascension, Island</i>	<i>Saint Helena</i>	SH (329)
<i>Astove, Island</i>	<i>Seychelles</i>	SC (355)

<i>Auckland, Islands</i>	<i>New Zealand</i>	NZ (804)
<i>Aunu'u, Island</i>	<i>American Samoa</i>	AS (830)
<i>Aurigny, Island</i>	<i>United Kingdom</i>	GB (006)
Australia		AU (800)
<i>Australian Antarctic Territory</i>	<i>Antarctica</i>	AQ (891)
Austria		AT (038)
<i>Aves, Island</i>	<i>Venezuela</i>	VE (484)
<i>Axel Heiberg, Island</i>	<i>Canada</i>	CA (404)
Azerbaijan		AZ (078)
<i>Azores, Archipelago of the</i>	<i>Portugal</i>	PT (010)
B		
<i>Babelthuap, Island</i>	<i>Palau</i>	PW (825)
<i>Baffin, Island</i>	<i>Canada</i>	CA (404)
Bahamas		BS (453)
<i>Bahia, Islands</i>	<i>Honduras</i>	HN (424)
Bahrain		BH (640)
<i>Baker, Island</i>	<i>United States Minor Outlying Islands</i>	UM (832)
<i>Balearic Islands</i>	<i>Spain</i>	ES (011)
<i>Bali, Island</i>	<i>Indonesia</i>	ID (700)
<i>Banaba, Island</i>	<i>Kiribati</i>	KI (812)
Bangladesh		BD (666)
<i>Banks, Island</i>	<i>Canada</i>	CA (404)
Barbados		BB (469)
<i>Barbuda, Island</i>	<i>Antigua and Barbuda</i>	AG (459)
<i>Barents, Island</i>	<i>Norway</i>	NO (028)
<i>Bear, Island</i>	<i>Norway</i>	NO (028)
Belarus		BY (073)
<i>Belep, Islands</i>	<i>New Caledonia</i>	NC (809)
Belgium		BE (017)
Belize		BZ (421)
<i>Belorussia</i>	<i>Belarus</i>	BY (073)
Benin		BJ (284)
<i>Bequia, Island</i>	<i>St Vincent and the Grenadines</i>	VC (467)
Bermuda		BM (413)
Bhutan		BT (675)
<i>Bijagos archipelago</i>	<i>Guinea-Bissau</i>	GW (257)
<i>Bimini, Island</i>	<i>Bahamas</i>	BS (453)
<i>Bioko, Island</i>	<i>Equatorial Guinea</i>	GQ (310)
<i>Bird, Island</i>	<i>Seychelles</i>	SC (355)
<i>Bismarck archipelago</i>	<i>Papua New Guinea</i>	PG (801)
<i>Boa Vista, Island</i>	<i>Cape Verde</i>	CV (247)
<i>Boaz, Island</i>	<i>Bermuda</i>	BM (413)
Bolivia		BO (516)
<i>Bonaire, Island</i>	<i>Netherlands Antilles</i>	AN (478)
<i>Borneo, Island</i>	<i>Brunei Darussalam</i>	BN (703)
<i>Borneo, Island</i>	<i>Indonesia</i>	ID (700)
<i>Bornholm, Island</i>	<i>Denmark</i>	DK (008)
Bosnia and Herzegovina		BA (093)
Botswana		BW (391)
<i>Boûbiyan, Island</i>	<i>Kuwait</i>	KW (636)
<i>Bougainville, Island</i>	<i>Papua New Guinea</i>	PG (801)
<i>Bounty, Islands</i>	<i>New Zealand</i>	NZ (804)
Bouvet Island		BV (892)
<i>Branco, Island</i>	<i>Cape Verde</i>	CV (247)
<i>Brava, Island</i>	<i>Cape Verde</i>	CV (247)
Brazil		BR (508)

<i>British Antarctic Territory</i>	<i>Antarctica</i>	AQ (891)
<i>British Channel Islands</i>	<i>United Kingdom</i>	GB (006)
<i>British Guiana</i>	<i>Guyana</i>	GY (488)
British Indian Ocean Territory		IO (357)
Brunei Darussalam		BN (703)
<i>Buka, Island</i>	<i>Papua New Guinea</i>	PG (801)
Bulgaria		BG (068)
Burkina Faso		BF (236)
<i>Burma</i>	<i>Myanmar</i>	MM (676)
Burundi		BI (328)
<i>Büsingen, Territory of</i>	<i>Switzerland</i>	CH (039)
C		
<i>Cabinda, Enclave of</i>	<i>Angola</i>	AO (330)
<i>Caicos, Islands</i>	<i>Turks and Caicos Islands</i>	TC (454)
<i>Camagüey, Archipelago</i>	<i>Cuba</i>	CU (448)
Cambodia		KH (696)
Cameroon		CM (302)
<i>Campbell, Island</i>	<i>New Zealand</i>	NZ (804)
<i>Campione d'Italia, the Italian municipality of</i>	<i>Switzerland</i>	CH (039)
Canada		CA (404)
<i>Canadian Arctic Archipelago</i>	<i>Canada</i>	CA (404)
<i>Canal Zone, The former</i>	<i>Panama</i>	PA (442)
<i>Canary Islands</i>	<i>Spain</i>	ES (011)
<i>Canouan, Island</i>	<i>St Vincent and the Grenadines</i>	VC (467)
Cape Verde		CV (247)
<i>Cargados Carajos Shoals, Islands</i>	<i>Mauritius</i>	MU (373)
<i>Caroline, Island</i>	<i>Micronesia, Federated States of</i>	FM (823)
<i>Carriacou, Island</i>	<i>Grenada</i>	GD (473)
<i>Cayman Brac, Island</i>	<i>Cayman Islands</i>	KY (463)
Cayman Islands		KY (463)
<i>Celebes, Island</i>	<i>Indonesia</i>	ID (700)
Central African Republic		CF (306)
<i>Cerf, Island</i>	<i>Seychelles</i>	SC (355)
Ceuta		XC (021)
<i>Ceylon</i>	<i>Sri Lanka</i>	LK (669)
Chad		TD (244)
<i>Chafarinas Islands</i>	<i>Melilla</i>	XL (023)
<i>Chagos archipelago</i>	<i>British Indian Ocean Territory</i>	IO (357)
<i>Channel Islands, British</i>	<i>United Kingdom</i>	GB (006)
<i>Chatham, Islands</i>	<i>New Zealand</i>	NZ (804)
<i>Cheju, Island</i>	<i>Korea, Republic of</i>	KR (728)
<i>Chesterfield, Islands</i>	<i>New Caledonia</i>	NC (809)
Chile		CL (512)
<i>Chiloé, Island</i>	<i>Chile</i>	CL (512)
China	<i>Chile</i>	CL (512)
<i>Chonos archipelago</i>		CN (720)
Christmas Island		CX (834)
<i>Chuuk</i>	<i>Micronesia, Federated States of</i>	FM (823)
<i>Clipperton, Island</i>	<i>French Polynesia</i>	PF (822)
<i>Coco, Island</i>	<i>Costa Rica</i>	CR (436)
Cocos (Keeling), Islands		CC (833)
<i>Coëtivy, Island</i>	<i>Seychelles</i>	SC (355)
<i>Coiba, Island</i>	<i>Panama</i>	PA (442)
Colombia		CO (480)
<i>Comino, Island</i>	<i>Malta</i>	MT (046)
<i>Cominotto, Island</i>	<i>Malta</i>	MT (046)

Comoros		KM (375)
<i>Conakry</i>	<i>Guinea</i>	GN (260)
Congo, Democratic Republic of		CD (322)
Congo		CG (318)
Cook Islands		CK (837)
<i>Corisco, Island</i>	<i>Equatorial Guinea</i>	GQ (310)
<i>Corn, Islands</i>	<i>Nicaragua</i>	NI (432)
<i>Coronation, Island</i>	<i>Antarctica</i>	AQ (891)
<i>Corsica</i>	<i>France</i>	FR (001)
<i>Corvo, Island</i>	<i>Portugal</i>	PT (010)
<i>Cosmoledo, Islands</i>	<i>Seychelles</i>	SC (355)
Costa Rica		CR (436)
Côte d'Ivoire		CI (272)
Croatia		HR (092)
<i>Crozet, archipelago</i>	<i>French Southern Territories</i>	TF (894)
Cuba		CU (448)
<i>Culebra, Island</i>	<i>United States</i>	US (400)
<i>Curaçao, Island</i>	<i>Netherlands Antilles</i>	AN (478)
<i>Curieuse, Island</i>	<i>Seychelles</i>	SC (355)
Cyprus		CY (600)
Czech Republic		CZ (061)

D

<i>Dahlak, archipelago</i>	<i>Eritrea</i>	ER (336)
<i>Deception, Island</i>	<i>Antarctica</i>	AQ (891)
<i>Democratic Republic of the Congo</i>	<i>Congo, Democratic Republic of</i>	CD (322)
<i>Denis, Island</i>	<i>Seychelles</i>	SC (355)
Denmark		DK (008)
<i>Dependencies of New Caledonia</i>	<i>New Caledonia</i>	NC (809)
<i>Dependencies of Seychelles</i>	<i>Seychelles</i>	SC (355)
<i>Dependencies of St Helena</i>	<i>Saint Helena</i>	SH (329)
<i>Dependency, Ross</i>	<i>Antarctica</i>	AQ (891)
<i>Desroches, Islands</i>	<i>Seychelles</i>	SC (355)
<i>Devon, Island</i>	<i>Canada</i>	CA (404)
<i>Djerba, Island</i>	<i>Tunisia</i>	TN (212)
Djibouti		DJ (338)
Dominica		DM (460)
Dominican Republic		DO (456)
<i>Dubai</i>	<i>United Arab Emirates</i>	AE (647)
<i>Ducie, Island</i>	<i>Pitcairn</i>	PN (813)
<i>Duke of York Islands</i>	<i>Papua New Guinea</i>	PG (801)
<i>Dutch Guiana</i>	<i>Suriname</i>	SR (492)

E

<i>East Jerusalem</i>	<i>Palestinian Territory, Occupied</i>	PS (625)
<i>Easter Island</i>	<i>Chile</i>	CL (512)
Ecuador		EC (500)
<i>Edge, Island</i>	<i>Norway</i>	NO (028)
<i>Efate, Island</i>	<i>Vanuatu</i>	VU (816)
Egypt		EG (220)
<i>Eire</i>	<i>Ireland</i>	IE (007)
<i>El Rey, Island</i>	<i>Panama</i>	PA (442)
El Salvador		SV (428)
<i>Elba, Island</i>	<i>Italy</i>	IT (005)
<i>Elephant, Island</i>	<i>Antarctica</i>	AQ (891)
<i>Eleuthera, Island</i>	<i>Bahamas</i>	BS (453)

<i>Ellesmere, Island</i>	Canada	CA (404)
<i>Elobeys, Islands</i>	Equatorial Guinea	GQ (310)
<i>Emirates, United Arab</i>	United Arab Emirates	AE (647)
<i>Entrecasteaux, Islands</i>	Papua New Guinea	PG (801)
Equatorial Guinea		GQ (310)
Eritrea		ER (336)
Estonia		EE (053)
Ethiopia		ET (334)
<i>Eua, Island</i>	Tonga	TO (817)
F		
<i>Faial, Island</i>	Portugal	PT (010)
<i>Faïlakah, Island</i>	Kuwait	KW (636)
Falkland Islands (Malvinas)		FK (529)
<i>Falster, Island</i>	Denmark	DK (008)
Faroe Islands		FO (041)
<i>Farquhar, Islands</i>	Seychelles	SC (355)
<i>Federated States of Micronesia</i>	Micronesia, Federated States of	FM (823)
<i>Federation, Russian</i>	Russian Federation	RU (075)
<i>Félicité, Island</i>	Seychelles	SC (355)
<i>Fernando de Noronha, Island</i>	Brazil	BR (508)
<i>Fernando Póo, Island</i>	Equatorial Guinea	GQ (310)
Fiji		FJ (815)
<i>Filfola, Island</i>	Malta	MT (046)
Finland		FI (032)
<i>Flores, Island</i>	Indonesia	ID (700)
<i>Flores, Island</i>	Portugal	PT (010)
<i>Fogo, Island</i>	Cape Verde	CV (247)
<i>Fongafale</i>	Tuvalu	TV (807)
<i>Formentera, Island</i>	Spain	ES (011)
<i>Former Yugoslav Republic of Macedonia</i>	Macedonia, Former Yugoslav Republic of	MK (096)
<i>Formosa</i>	Taiwan	TW (736)
France		FR (001)
<i>Franz Josef Land</i>	Russian Federation	RU (075)
<i>Frégate, Island</i>	Seychelles	SC (355)
<i>French Guiana</i>	France	FR (001)
French Polynesia		PF (822)
French Southern Territories		TF (894)
<i>Fuego, Tierra del</i>	Argentina	AR (528)
<i>Fuego, Tierra del</i>	Chile	CL (512)
<i>Fuerteventura, Island</i>	Spain	ES (011)
<i>Fujairah</i>	United Arab Emirates	AE (647)
<i>Funafuti, Atoll</i>	Tuvalu	TV (807)
<i>Funen, Island</i>	Denmark	DK (008)
<i>Futuna, Island</i>	Wallis and Futuna	WF (811)
G		
Gabon		GA (314)
<i>Galapagos, Islands</i>	Ecuador	EC (500)
Gambia		GM (252)
<i>Gambier, Islands</i>	French Polynesia	PF (822)
<i>Gaza Strip</i>	Palestinian Territory, Occupied	PS (625)
Georgia		GE (076)
<i>German Territory of Büsingen</i>	Switzerland	CH (039)
Germany		DE (004)

Ghana		GH (276)
Gibraltar		GI (044)
<i>Gilbert, Islands</i>	<i>Kiribati</i>	<i>KI (812)</i>
<i>Gomera, Island</i>	<i>Spain</i>	<i>ES (011)</i>
<i>Gonâve, Island</i>	<i>Haiti</i>	<i>HT (452)</i>
<i>Gorée, Island</i>	<i>Senegal</i>	<i>SN (248)</i>
<i>Gotland, Island</i>	<i>Sweden</i>	<i>SE (030)</i>
<i>Gough, Island</i>	<i>Saint Helena</i>	<i>SH (329)</i>
<i>Gozo, Island</i>	<i>Malta</i>	<i>MT (046)</i>
<i>Graciosa, Island</i>	<i>Portugal</i>	<i>PT (010)</i>
<i>Gran Canaria, Island</i>	<i>Spain</i>	<i>ES (011)</i>
<i>Grand Bahama, Island</i>	<i>Bahamas</i>	<i>BS (453)</i>
<i>Grand Cayman, Island</i>	<i>Cayman Islands</i>	<i>KY (463)</i>
<i>Grand Turk, Island</i>	<i>Turks and Caicos Islands</i>	<i>TC (454)</i>
<i>Grande Cayemite, Island</i>	<i>Haiti</i>	<i>HT (452)</i>
<i>Grande Comore, Island</i>	<i>Comoros</i>	<i>KM (375)</i>
<i>Grande-Terre</i>	<i>Mayotte</i>	<i>YT (377)</i>
<i>Great Abaco, Island</i>	<i>Bahamas</i>	<i>BS (453)</i>
<i>Great Bermuda, Island</i>	<i>Bermuda</i>	<i>BM (413)</i>
<i>Great Britain</i>	<i>United Kingdom</i>	<i>GB (006)</i>
<i>Great Inagua, Island</i>	<i>Bahamas</i>	<i>BS (453)</i>
Greece		GR (009)
<i>Green, Islands</i>	<i>Papua New Guinea</i>	<i>PG (801)</i>
Greenland		GL (406)
Grenada		GD (473)
<i>Guadeloupe, Island</i>	<i>France</i>	<i>FR (001)</i>
Guam		GU (831)
Guatemala		GT (416)
<i>Guernsey, Island</i>	<i>United Kingdom</i>	<i>GB (006)</i>
<i>Guiana, French</i>	<i>France</i>	<i>FR (001)</i>
Guinea		GN (260)
Guinea-Bissau		GW (257)
Guyana		GY (488)
H		
<i>Ha'apai, Islands</i>	<i>Tonga</i>	<i>TO (817)</i>
Haiti		HT (452)
<i>Harbour, Island</i>	<i>Bahamas</i>	<i>BS (453)</i>
<i>Hawaiian, Islands</i>	<i>United States</i>	<i>US (400)</i>
Heard Island and McDonald Islands		HM (835)
<i>Heard, Island</i>	<i>Heard Island and McDonald Islands</i>	<i>HM (835)</i>
<i>Heligoland, Island</i>	<i>Germany</i>	<i>DE (004)</i>
<i>Henderson, Island</i>	<i>Pitcairn</i>	<i>PN (813)</i>
<i>Herzegovina, Bosnia and</i>	<i>Bosnia and Herzegovina</i>	<i>BA (093)</i>
<i>Hierro, Island</i>	<i>Spain</i>	<i>ES (011)</i>
<i>Hiiumaa, Island</i>	<i>Estonia</i>	<i>EE (053)</i>
<i>Hispaniola</i>	<i>Haiti</i>	<i>HT (452)</i>
<i>Hokkaido, Island</i>	<i>Japan</i>	<i>JP (732)</i>
Holy See (Vatican City State)		VA (045)
Honduras		HN (424)
Hong Kong		HK (740)
<i>Honshu, Island</i>	<i>Japan</i>	<i>JP (732)</i>
<i>Hooru, Islands</i>	<i>Wallis and Futuna</i>	<i>WF (811)</i>
<i>Horn, Islands</i>	<i>Wallis and Futuna</i>	<i>WF (811)</i>
<i>Howland, Island</i>	<i>United States Minor Outlying Islands</i>	<i>UM (832)</i>
Hungary		HU (064)
<i>Huon, Island</i>	<i>New Caledonia</i>	<i>NC (809)</i>

I

<i>Ibiza</i>	<i>Spain</i>	ES	(011)
Iceland		IS	(024)
<i>Île à Vache</i>	<i>Haiti</i>	HT	(452)
<i>Inaccessible, Island</i>	<i>Saint Helena</i>	SH	(329)
India		IN	(664)
<i>Indian Ocean Territory, British</i>	<i>British Indian Ocean Territory</i>	IO	(357)
Indonesia		ID	(700)
Iran, Islamic Republic of		IR	(616)
Iraq		IQ	(612)
<i>Ireland, Island</i>	<i>Bermuda</i>	BM	(413)
Ireland		IE	(007)
<i>Irian Jaya, Island</i>	<i>Indonesia</i>	ID	(700)
<i>Isabela, Island</i>	<i>Ecuador</i>	EC	(500)
<i>Isle of Man</i>	<i>United Kingdom</i>	GB	(006)
Israel		IL	(624)
<i>Italian municipality of Campione d'Italia</i>	<i>Switzerland</i>	CH	(039)
Italy		IT	(005)
<i>Ivory Coast</i>	<i>Côte d'Ivoire</i>	CI	(272)

J

Jamaica		JM	(464)
<i>Jan Mayen, Island</i>	<i>Norway</i>	NO	(028)
Japan		JP	(732)
<i>Jarvis, Island</i>	<i>United States Minor Outlying Islands</i>	UM	(832)
<i>Java, Island</i>	<i>Indonesia</i>	ID	(700)
<i>Jersey, Island</i>	<i>United Kingdom</i>	GB	(006)
<i>Johnston, Atoll</i>	<i>United States Minor Outlying Islands</i>	UM	(832)
Jordan		JO	(628)
<i>Jost Van Dyke</i>	<i>Virgin Islands, British</i>	VG	(468)
<i>Juan Fernández, Islands</i>	<i>Chile</i>	CL	(512)
<i>Juventud, Island</i>	<i>Cuba</i>	CU	(448)

K

<i>Kalimantal, Island</i>	<i>Indonesia</i>	ID	(700)
<i>Kaliningrad, Enclave of</i>	<i>Russian Federation</i>	RU	(075)
<i>Kamaran, Island</i>	<i>Yemen</i>	YE	(653)
Kazakhstan		KZ	(079)
<i>Keeling, Islands</i>	<i>Cocos (Keeling), Islands</i>	CC	(833)
Kenya		KE	(346)
<i>Kerguelen, Islands</i>	<i>French Southern Territories</i>	TF	(894)
<i>Kermadec, Island</i>	<i>New Zealand</i>	NZ	(804)
<i>King Charles, Land</i>	<i>Norway</i>	NO	(028)
<i>King George, Island</i>	<i>Antarctica</i>	AQ	(891)
<i>Kingman Reef</i>	<i>United States Minor Outlying Islands</i>	UM	(832)
<i>Kinmen</i>	<i>Taiwan</i>	TW	(736)
Kiribati		KI	(812)
Korea, Democratic People's Republic of		KP	(724)
Korea, Republic of		KR	(728)
<i>Korea, South</i>	<i>Korea, Republic of</i>	KR	(728)
<i>Koror, Island</i>	<i>Palau</i>	PW	(825)
Kosovo		XK	(095)
<i>Kosrae</i>	<i>Micronesia, Federated States of</i>	FM	(823)

<i>Kowloon</i>	<i>Hong Kong</i>	HK (740)
<i>Kuril, Islands</i>	<i>Russian Federation</i>	RU (075)
Kuwait		KW (636)
<i>Kyrgyz Republic</i>	<i>Kyrgyz, Republic</i>	KG (083)
Kyrgyz, Republic		KG (083)
<i>Kyushu</i>	<i>Japan</i>	JP (732)

L

<i>La Digue, Island</i>	<i>Seychelles</i>	SC (355)
<i>La Palma, Island</i>	<i>Spain</i>	ES (011)
<i>Labuan</i>	<i>Malaysia</i>	MY (701)
<i>Laccadive, Island</i>	<i>India</i>	IN (664)
<i>Langeland, Island</i>	<i>Denmark</i>	DK (008)
<i>Lantao, Island</i>	<i>Hong Kong</i>	HK (740)
<i>Lanzarote, Island</i>	<i>Spain</i>	ES (011)
Lao People's Democratic Republic		LA (684)
<i>Laos</i>	<i>Lao People's Democratic Republic</i>	LA (684)
<i>Las Perlas archipelago</i>	<i>Panama</i>	PA (442)
Latvia		LV (054)
<i>Laurie, Island</i>	<i>Antarctica</i>	AQ (891)
<i>Lavongai</i>	<i>Papua New Guinea</i>	PG (801)
Lebanon		LB (604)
<i>Leeward, Islands</i>	<i>French Polynesia</i>	PF (822)
<i>Leeward, Islands</i>	<i>Montserrat</i>	MS (470)
<i>Leeward, Netherlands Islands</i>	<i>Netherlands Antilles</i>	AN (478)
Lesotho		LS (395)
Liberia		LR (268)
<i>Libya</i>	<i>Libyan Arab Jamahiriya</i>	LY (216)
Libyan Arab Jamahiriya		LY (216)
Liechtenstein		LI (037)
<i>Lifou, Island</i>	<i>New Caledonia</i>	NC (809)
<i>Ligne, Islands</i>	<i>Kiribati</i>	KI (812)
Lithuania		LT (055)
<i>Little Cayman, Island</i>	<i>Cayman Islands</i>	KY (463)
<i>Livigno</i>	<i>Italy</i>	IT (005)
<i>Lolland, Island</i>	<i>Denmark</i>	DK (008)
<i>Long, Island</i>	<i>Bahamas</i>	BS (453)
<i>Los Canarreosa, Archipelago</i>	<i>Cuba</i>	CU (448)
<i>Los Colorados, Archipelago</i>	<i>Cuba</i>	CU (448)
<i>Los Islands</i>	<i>Guinea</i>	GN (260)
<i>Los Jardines de la Reina, Archipelago</i>	<i>Cuba</i>	CU (448)
<i>Louisiade archipelago</i>	<i>Papua New Guinea</i>	PG (801)
<i>Loyalty, Islands</i>	<i>New Caledonia</i>	NC (809)
Luxembourg		LU (018)
<i>Luzon, Island</i>	<i>Philippines</i>	PH (708)

M

Macao		MO (743)
Macedonia, Former Yugoslav Republic of		MK (096)
Madagascar		MG (370)
<i>Madeira, Archipelago of</i>	<i>Portugal</i>	PT (010)
<i>Mafia, Island</i>	<i>Tanzania, United Republic of</i>	TZ (352)
<i>Mahé, Island</i>	<i>Seychelles</i>	SC (355)
<i>Mahoré</i>	<i>Mayotte</i>	YT (377)
<i>Main Island</i>	<i>Bermuda</i>	BM (413)
<i>Maio, Island</i>	<i>Cape Verde</i>	CV (247)

<i>Majorca</i>	<i>Spain</i>	ES (011)
Malawi		MW (386)
Malaysia		MY (701)
Maldives		MV (667)
<i>Malekula, Island</i>	<i>Vanuatu</i>	VU (816)
Mali		ML (232)
<i>Malpelo, Island</i>	<i>Colombia</i>	CO (480)
Malta		MT (046)
<i>Malvinas, Island</i>	<i>Falkland Islands (Malvinas)</i>	FK (529)
<i>Mamelles, Islands</i>	<i>Seychelles</i>	SC (355)
<i>Man, Isle of</i>	<i>United Kingdom</i>	GB (006)
<i>Mangareva, Island</i>	<i>French Polynesia</i>	PF (822)
<i>Manono, Island</i>	<i>Samoa</i>	WS (819)
<i>Maoré</i>	<i>Mayotte</i>	YT (377)
<i>Maré, Island</i>	<i>New Caledonia</i>	NC (809)
<i>Margarita, Island</i>	<i>Venezuela</i>	VE (484)
<i>Marion, Island</i>	<i>South Africa</i>	ZA (388)
<i>Marquesas, Island</i>	<i>French Polynesia</i>	PF (822)
Marshall Islands		MH (824)
<i>Martim Vaz, Island</i>	<i>Brazil</i>	BR (508)
<i>Martinique, Island</i>	<i>France</i>	FR (001)
<i>Matsu, Islands</i>	<i>Taiwan</i>	TW (736)
<i>Maud, Queen - Land</i>	<i>Antarctica</i>	AQ (891)
Mauritania		MR (228)
Mauritius		MU (373)
<i>Mayaguana, Island</i>	<i>Bahamas</i>	BS (453)
<i>Mayen, Jan - Island</i>	<i>Norway</i>	NO (028)
Mayotte		YT (377)
<i>Mayreau, Island</i>	<i>St Vincent and the Grenadines</i>	VC (467)
<i>Mbini</i>	<i>Equatorial Guinea</i>	GQ (310)
<i>McDonald, Island</i>	<i>Heard Island and McDonald Islands</i>	HM (835)
Melilla		XL (023)
<i>Melville, Island</i>	<i>Canada</i>	CA (404)
Mexico		MX (412)
Micronesia, Federated States of		FM (823)
<i>Midway, Island</i>	<i>United States Minor Outlying Islands</i>	UM (832)
<i>Mindanao, Island</i>	<i>Philippines</i>	PH (708)
<i>Mindoro, Island</i>	<i>Philippines</i>	PH (708)
<i>Minicoy, Island</i>	<i>India</i>	IN (664)
<i>Minorca</i>	<i>Spain</i>	ES (011)
<i>Miquelon, Island</i>	<i>Saint Pierre and Miquelon</i>	PM (408)
<i>Mohéli</i>	<i>Comoros</i>	KM (375)
<i>Moili, Island</i>	<i>Comoros</i>	KM (375)
<i>Moldavia</i>	<i>Moldova, Republic of</i>	MD (074)
Moldova, Republic of		MD (074)
<i>Moluccan, Islands</i>	<i>Indonesia</i>	ID (700)
<i>Møn, Island</i>	<i>Denmark</i>	DK (008)
<i>Mona, Island</i>	<i>United States</i>	US (400)
<i>Monaco</i>	<i>France</i>	FR (001)
Mongolia		MN (716)
Montenegro		ME (097)
Montserrat		MS (470)
Morocco		MA (204)
<i>Mouharraq, Island</i>	<i>Bahrain</i>	BH (640)
<i>Moussandam peninsula</i>	<i>Oman</i>	OM (649)
Mozambique		MZ (366)
<i>Municipality, The Italian - of Campione d'Italia</i>	<i>Switzerland</i>	CH (039)
<i>Mustique, Island</i>	<i>St Vincent and the Grenadines</i>	VC (467)
<i>Mwali</i>	<i>Comoros</i>	KM (375)

Myanmar**MM (676)****N***Nagorno-Karabakh**Nakhichevan***Namibia****Nauru***Navassa, Island**Ndzouani, Island**Negara Brunei Darussalam***Nepal****Netherlands Antilles****Netherlands***Nevis**New Amsterdam, Island**New Britain***New Caledonia***New Guinea, Papua**New Hanover**New Ireland**New Providence, Island**New Siberian Islands**New Territories***New Zealand***Ngazidja**Ngwane***Nicaragua***Nicobar, Islands***Niger****Nigeria***Nightingale, Island**Niuas, Island***Niue***Nord, Island***Norfolk Island***North Korea**North Yemen**North-East Land**Northern Grenadine Islands**Northern Ireland***Northern Mariana Islands***Northern Solomon Islands***Norway***Nosy-Be, Island**Novaya Zemlya**Nzwani**Azerbaijan**Azerbaijan**AZ (078)**AZ (078)***NA (389)****NR (803)***United States Minor Outlying Islands**UM (832)**Comoros**KM (375)**Brunei Darussalam**BN (703)***NP (672)****AN (478)****NL (003)***St Kitts and Nevis**KN (449)**French Southern Territories**TF (894)**Papua New Guinea**PG (801)***NC (809)***Papua New Guinea**PG (801)**Papua New Guinea**PG (801)**Papua New Guinea**PG (801)**Bahamas**BS (453)**Russian Federation**RU (075)**Hong Kong**HK (740)***NZ (804)***Comoros**KM (375)**Swaziland**SZ (393)***NI (432)***India**IN (664)***NE (240)****NG (288)***Saint Helena**SH (329)**Tonga**TO (817)***NU (838)***Seychelles**SC (355)***NF (836)***Korea, Democratic People's Republic of**KP (724)**Yemen**YE (653)**Norway**NO (028)**St Vincent and the Grenadines**VC (467)**United Kingdom**GB (006)***MP (820)***Papua New Guinea**PG (801)***NO (028)***Madagascar**MG (370)**Russian Federation**RU (075)**Comoros**KM (375)***O***Occupied Palestinian Territory**Ocean, Island**Oeno, Island**Ofu, Island**Oil Islands**Öland, Island**Olosega, Island***Oman***Palestinian Territory, Occupied**PS (625)**Kiribati**KI (812)**Pitcairn**PN (813)**American Samoa**AS (830)**British Indian Ocean Territory**IO (357)**Sweden**SE (030)**American Samoa**AS (830)***OM (649)**

Ouvéa, Island

P

Pagalu, Islet

Pakistan

Palaos

Palau

Palawan, Island

Palestinian Territory, Occupied

Palmyra, Atoll

Pamandzi

Panama

Papua New Guinea

Paraguay

Parry, Islands

Pedras Tinhosas, Islands

Pemba, Island

Penghu, Islands

Peñón de Alhucemas

Peñón de Vélez de la Gomera

Perim, Island

Peru

Pescadores, Islands

Peter 1st, Island

Peter, Island

Petit Martinique, Island

Philippines

Phoenix, Island

Pico, Island

Pines, Island

Pinos, Island

Pitcairn

Platte, Island

Pohnpei

Poland

Polynesia, French

Ponape

Porto Santo, Island

Portugal

Praslin, Island

Prince Charles Island

Prince Edouard

Principe, Island

Providence, Island

Providencia Island

Puerto Rico, Island

New Caledonia

NC (809)

Equatorial Guinea

GQ (310)

PK (662)

Palau

PW (825)

PW (825)

Philippines

PH (708)

PS (625)

United States Minor Outlying Islands

UM (832)

Mayotte

YT (377)

PA (442)

PG (801)

PY (520)

Canada

CA (404)

Sao Tome and Principe

ST (311)

Tanzania, United Republic of

TZ (352)

Taiwan

TW (736)

Melilla

XL (023)

Melilla

XL (023)

Yemen

YE (653)

PE (504)

Taiwan

TW (736)

Antarctica

AQ (891)

Virgin Islands, British

VG (468)

Grenada

GD (473)

PH (708)

Kiribati

KI (812)

Portugal

PT (010)

New Caledonia

NC (809)

Cuba

CU (448)

PN (813)

Seychelles

SC (355)

Micronesia, Federated States of

FM (823)

PL (060)

French Polynesia

PF (822)

Micronesia, Federated States of

FM (823)

Portugal

PT (010)

PT (010)

Seychelles

SC (355)

Norway

NO (028)

South Africa

ZA (388)

Sao Tome and Principe

ST (311)

Seychelles

SC (355)

Colombia

CO (480)

United States

US (400)

Q

Qatar		QA (644)
<i>Queen Maud Land</i>	<i>Antarctica</i>	AQ (891)
<i>Quemoy, Islands</i>	<i>Taiwan</i>	TW (736)

R

<i>Raivavaé, Island</i>	<i>French Polynesia</i>	PF (822)
<i>Ralik, Islands</i>	<i>Marshall Islands</i>	MH (824)
<i>Rapa, Island</i>	<i>French Polynesia</i>	PF (822)
<i>Rarotonga</i>	<i>Cook Islands</i>	CK (837)
<i>Ras al Khaimah</i>	<i>United Arab Emirates</i>	AE (647)
<i>Raso, Island</i>	<i>Cape Verde</i>	CV (247)
<i>Ratak, Islands</i>	<i>Marshall Islands</i>	MH (824)
<i>Récifs, Islands</i>	<i>Seychelles</i>	SC (355)
<i>Redonda, Island</i>	<i>Antigua and Barbuda</i>	AG (459)
<i>Republic of Palau</i>	<i>Palau</i>	PW (825)
<i>Republic of the Congo, Democratic</i>	<i>Congo, Democratic Republic of</i>	CD (322)
<i>Republic, Central African</i>	<i>Central African Republic</i>	CF (306)
<i>Republic, Czech</i>	<i>Czech Republic</i>	CZ (061)
<i>Republic, Dominican</i>	<i>Dominican Republic</i>	DO (456)
<i>Republic, Former Yugoslav - of Macedonia</i>	<i>Macedonia, Former Yugoslav Republic</i>	MK (096)
<i>Réunion, Island</i>	<i>France</i>	FR (001)
<i>Rimatara, Island</i>	<i>French Polynesia</i>	PF (822)
<i>Rio Muni</i>	<i>Equatorial Guinea</i>	GQ (310)
<i>Rodrigues, Island</i>	<i>Mauritius</i>	MU (373)
<i>Rolas, Island</i>	<i>Sao Tome and Principe</i>	ST (311)
Romania		RO (066)
<i>Rombo, Island</i>	<i>Cape Verde</i>	CV (247)
<i>Rose, Island</i>	<i>American Samoa</i>	AS (830)
<i>Ross Dependency</i>	<i>Antarctica</i>	AQ (891)
<i>Rota, Island</i>	<i>Northern Mariana Islands</i>	MP (820)
<i>Rotuma, Island</i>	<i>Fiji</i>	FJ (815)
<i>Rurutu, Island</i>	<i>French Polynesia</i>	PF (822)
Russian Federation		RU (075)
Rwanda		RW (324)

S

<i>Saaremaa, Island</i>	<i>Estonia</i>	EE (053)
<i>Saba, Island</i>	<i>Netherlands Antilles</i>	AN (478)
<i>Sabah</i>	<i>Malaysia</i>	MY (701)
<i>Sabana, Archipelago</i>	<i>Cuba</i>	CU (448)
Saint Helena		SH (329)
Saint Lucia		LC (465)
<i>Saint Paul, Island</i>	<i>French Southern Territories</i>	TF (894)
Saint Pierre and Miquelon		PM (408)
<i>Saint-Pierre, Island</i>	<i>Seychelles</i>	SC (355)
<i>Saipan, Island</i>	<i>Northern Mariana Islands</i>	MP (820)
<i>Sakhalin, Island</i>	<i>Russian Federation</i>	RU (075)
<i>Sal, Island</i>	<i>Cape Verde</i>	CV (247)
<i>Sala y Gomez, Island</i>	<i>Chile</i>	CL (512)
<i>Salt Cay, Island</i>	<i>Turks and Caicos Islands</i>	TC (454)

<i>Salt, Island</i>	<i>Virgin Islands, British</i>	VG (468)
Samoa		WS (819)
<i>San Ambrosio, Island</i>	<i>Chile</i>	CL (512)
<i>San Andrés Islands</i>	<i>Colombia</i>	CO (480)
<i>San Cristobal</i>	<i>Ecuador</i>	EC (500)
<i>San Félix, Island</i>	<i>Chile</i>	CL (512)
San Marino		SM (047)
<i>San Salvador, Island</i>	<i>Bahamas</i>	BS (453)
<i>Santa Cruz Islands</i>	<i>Solomon Islands</i>	SB (806)
<i>Santa Luzia, Island</i>	<i>Cape Verde</i>	CV (247)
<i>Santa Maria, Island</i>	<i>Portugal</i>	PT (010)
<i>Santiago, Island</i>	<i>Cape Verde</i>	CV (247)
<i>Santo Antão, Island</i>	<i>Cape Verde</i>	CV (247)
<i>Santo, Island</i>	<i>Vanuatu</i>	VU (816)
<i>São Jorge, Island</i>	<i>Portugal</i>	PT (010)
<i>São Miguel, Island</i>	<i>Portugal</i>	PT (010)
<i>São Nicolau, Island</i>	<i>Cape Verde</i>	CV (247)
Sao Tome and Principe		ST (311)
<i>Sao Tome, Island</i>	<i>Sao Tome and Principe</i>	ST (311)
<i>São Vicente, Island</i>	<i>Cape Verde</i>	CV (247)
<i>Saona Island</i>	<i>Dominican Republic</i>	DO (456)
<i>Sarawak</i>	<i>Malaysia</i>	MY (701)
<i>Sardinia, Island</i>	<i>Italy</i>	IT (005)
<i>Sark, Island</i>	<i>United Kingdom</i>	GB (006)
Saudi Arabia		SA (632)
<i>Savai'i, Island</i>	<i>Samoa</i>	WS (819)
Senegal		SN (248)
Serbia and Montenegro		YU (094)
Serbia		XS (098)
<i>Severnya Zemlya</i>	<i>Russian Federation</i>	RU (075)
Seychelles		SC (355)
<i>Sharjah</i>	<i>United Arab Emirates</i>	AE (647)
<i>Sherbro, Island</i>	<i>Sierra Leone</i>	SL (264)
<i>Shikoku</i>	<i>Japan</i>	JP (732)
<i>Siberian, New - Archipelago</i>	<i>Russian Federation</i>	RU (075)
<i>Sicily, Island</i>	<i>Italy</i>	IT (005)
Sierra Leone		SL (264)
<i>Sikkim</i>	<i>India</i>	IN (664)
<i>Silhouette, Island</i>	<i>Seychelles</i>	SC (355)
Singapore		SG (706)
<i>Sint Eustatius, Island</i>	<i>Netherlands Antilles</i>	AN (478)
<i>Sint Maarten, Island</i>	<i>Netherlands Antilles</i>	AN (478)
<i>Sitrah, Island</i>	<i>Bahrain</i>	BH (640)
Slovakia		SK (063)
Slovenia		SI (091)
<i>Snares Island</i>	<i>New Zealand</i>	NZ (804)
<i>Snares Islands</i>	<i>New Zealand</i>	NZ (804)
<i>Society, Islands</i>	<i>French Polynesia</i>	PF (822)
<i>Socotra, Island</i>	<i>Yemen</i>	YE (653)
Solomon Islands		SB (806)
Somalia		SO (342)
<i>Sombrero, Island</i>	<i>Anguilla</i>	AI (446)
<i>Somerset, Island</i>	<i>Bermuda</i>	BM (413)
South Africa		ZA (388)
<i>South Georgia</i>	<i>South Georgia and South Sandwich Islands</i>	GS (893)
South Georgia and South Sandwich Islands		GS (893)
<i>South Korea</i>	<i>Korea, Republic of</i>	KR (728)
<i>South Orkney, Islands</i>	<i>Antarctica</i>	AQ (891)
<i>South Ossetia</i>	<i>Georgia</i>	GE (076)

<i>South Sandwich, Islands</i>	<i>South Georgia and South Sandwich Islands</i>	GS	(893)
<i>South Shetland, Islands</i>	<i>Antarctica</i>	AQ	(891)
<i>South Solomon, Island</i>	<i>Solomon Islands</i>	SB	(806)
<i>South Yemen</i>	<i>Yemen</i>	YE	(653)
<i>Southern and Antarctic Territories</i>	<i>Antarctica</i>	AQ	(891)
<i>Southern Grenadine Islands</i>	<i>Grenada</i>	GD	(473)
<i>Southern, French- Territories</i>	<i>French Southern Territories</i>	TF	(894)
Spain		ES	(011)
<i>Spitsbergen, Island</i>	<i>Norway</i>	NO	(028)
Sri Lanka		LK	(669)
<i>St Barthélemy, Island</i>	<i>France</i>	FR	(001)
<i>St Brandon, Islands</i>	<i>Mauritius</i>	MU	(373)
<i>St Christopher</i>	<i>St Kitts and Nevis</i>	KN	(449)
<i>St Croix, Island</i>	<i>Virgin Islands (US)</i>	VI	(457)
<i>St David, Island</i>	<i>Bermuda</i>	BM	(413)
<i>St George, Island</i>	<i>Bermuda</i>	BM	(413)
<i>St Helena</i>	<i>Saint Helena</i>	SH	(329)
<i>St John, Island</i>	<i>Virgin Islands (US)</i>	VI	(457)
<i>St Kitts</i>	<i>St Kitts and Nevis</i>	KN	(449)
St Kitts and Nevis		KN	(449)
<i>St Martin, Island, northern part of</i>	<i>France</i>	FR	(001)
<i>St Martin, Island, southern part of</i>	<i>Netherlands Antilles</i>	AN	(478)
<i>St Paul, Island</i>	<i>French Southern Territories</i>	TF	(894)
<i>St Thomas, Island</i>	<i>Virgin Islands (US)</i>	VI	(457)
St Vincent and the Grenadines		VC	(467)
<i>St Vincent, Island</i>	<i>St Vincent and the Grenadines</i>	VC	(467)
<i>Staten Island</i>	<i>Argentina</i>	AR	(528)
<i>States of Micronesia</i>	<i>Micronesia, Federated States of</i>	FM	(823)
<i>Stoncutters, Islands</i>	<i>Hong Kong</i>	HK	(740)
Sudan		SD	(224)
<i>Sulawesi, Island</i>	<i>Indonesia</i>	ID	(700)
<i>Sumatra, Island</i>	<i>Indonesia</i>	ID	(700)
Suriname		SR	(492)
<i>Surprise, Islands</i>	<i>New Caledonia</i>	NC	(809)
<i>Svalbard archipelago</i>	<i>Norway</i>	NO	(028)
<i>Sverdrupp, Islands</i>	<i>Canada</i>	CA	(404)
<i>Swains, Island</i>	<i>American Samoa</i>	AS	(830)
<i>Swan, Islands</i>	<i>Honduras</i>	HN	(424)
Swaziland		SZ	(393)
Sweden		SE	(030)
Switzerland		CH	(039)
<i>Syria</i>	<i>Syrian Arab Republic</i>	SY	(608)
Syrian Arab Republic		SY	(608)

T

<i>Tahiti, Island</i>	<i>French Polynesia</i>	PF	(822)
Taiwan		TW	(736)
Tajikistan		TJ	(082)
<i>Tanganyika</i>	<i>Tanzania, United Republic of</i>	TZ	(352)
<i>Tanna, Island</i>	<i>Vanuatu</i>	VU	(816)
Tanzania, United Republic of		TZ	(352)
<i>Ta'u, Island</i>	<i>American Samoa</i>	AS	(830)
<i>Tenerife, Island</i>	<i>Spain</i>	ES	(011)
<i>Terceira, Island</i>	<i>Portugal</i>	PT	(010)
<i>Territories, French Southern</i>	<i>French Southern Territories</i>	TF	(894)
<i>Territory of Campione d'Italia</i>	<i>Switzerland</i>	CH	(039)
<i>Territory, Australian Antarctic</i>	<i>Antarctica</i>	AQ	(891)

<i>Territory, British Antarctic</i>	<i>Antarctica</i>	AQ (891)
<i>Territory, British Indian Ocean</i>	<i>British Indian Ocean Territory</i>	IO (357)
<i>Territory, German - of Büsingen</i>	<i>Switzerland</i>	CH (039)
Thailand		TH (680)
<i>The municipality of Campione d'Italia</i>	<i>Switzerland</i>	CH (039)
<i>Three Kings, Islands</i>	<i>New Zealand</i>	NZ (804)
<i>Tierra del Fuego</i>	<i>Argentina</i>	AR (528)
<i>Tierra del Fuego</i>	<i>Chile</i>	CL (512)
<i>Timor, Island</i>	<i>Indonesia</i>	ID (700)
Timor-Leste		TL (626)
<i>Tinian, Island</i>	<i>Northern Mariana Islands</i>	MP (820)
<i>Tobago, Island</i>	<i>Trinidad and Tobago</i>	TT (472)
Togo		TG (280)
Tokelau		TK (839)
Tonga		TO (817)
<i>Tongatapu, Island</i>	<i>Tonga</i>	TO (817)
<i>Tortola</i>	<i>Virgin Islands, British</i>	VG (468)
<i>Tortue, Island</i>	<i>Haiti</i>	HT (452)
Trinidad and Tobago		TT (472)
<i>Trinidad, Island</i>	<i>Trinidad and Tobago</i>	TT (472)
<i>Tristan da Cunha, Archipelago</i>	<i>Saint Helena</i>	SH (329)
<i>Trobriand, Islands</i>	<i>Papua New Guinea</i>	PG (801)
<i>Truk</i>	<i>Micronesia, Federated States of</i>	FM (823)
<i>Tuamotu archipelago</i>	<i>French Polynesia</i>	PF (822)
<i>Tubuai, Island</i>	<i>French Polynesia</i>	PF (822)
Tunisia		TN (212)
Turkey		TR (052)
Turkmenistan		TM (080)
Turks and Caicos Islands		TC (454)
<i>Turks, Island</i>	<i>Turks and Caicos Islands</i>	TC (454)
<i>Turneffe, Islands</i>	<i>Belize</i>	BZ (421)
<i>Tutuila, Island</i>	<i>American Samoa</i>	AS (830)
Tuvalu		TV (807)
U		
Uganda		UG (350)
Ukraine		UA (072)
<i>Ulster</i>	<i>United Kingdom</i>	GB (006)
<i>Umm al Qaiwain</i>	<i>United Arab Emirates</i>	AE (647)
<i>Union, Island</i>	<i>St Vincent and the Grenadines</i>	VC (467)
United Arab Emirates		AE (647)
United Kingdom		GB (006)
United States Minor Outlying Islands		UM (832)
United States		US (400)
<i>Upolu, Island</i>	<i>Samoa</i>	WS (819)
<i>Upper Nagorno - Karabakh</i>	<i>Azerbaijan</i>	AZ (078)
<i>Upper Volta</i>	<i>Burkina Faso</i>	BF (236)
Uruguay		UY (524)
<i>Uvea, Island</i>	<i>Wallis and Futuna</i>	WF (811)
Uzbekistan		UZ (081)
V		
<i>Vache, Île à</i>	<i>Haiti</i>	HT (452)
<i>Vanua Levu, Island</i>	<i>Fiji</i>	FJ (815)
Vanuatu		VU (816)

Vatican	Holy See (Vatican City State)	VA (045)
Vava'u, Islands	Tonga	TO (817)
Venezuela		VE (484)
Victoria, Island	Canada	CA (404)
Vieques, Island	United States	US (400)
Viet-Nam		VN (690)
Virgin Gorda	Virgin Islands, British	VG (468)
Virgin Islands (US)		VI (457)
Virgin Islands, British		VG (468)
Virgin, (US) Islands	Virgin Islands (US)	VI (457)
Virgin, British- Islands	Virgin Islands, British	VG (468)
Visayas archipelago	Philippines	PH (708)
Viti Levu, Island	Fiji	FJ (815)

W

Wake, Island	United States Minor Outlying Islands	UM (832)
Wallis and Futuna		WF (811)
Wallis, Islands	Wallis and Futuna	WF (811)
Walpole, Island	New Caledonia	NC (809)
Warbah, Island	Kuwait	KW (636)
Wellington, Island	Chile	CL (512)
West Bank	Palestinian Territory, Occupied	PS (625)
Western Samoa	Samoa	WS (819)
Windward, Islands	French Polynesia	PF (822)
Windward, Netherlands Islands	Netherlands Antilles	AN (478)
Woodlark, Island	Papua New Guinea	PG (801)
Wrangel, Island	Russian Federation	RU (075)

Y

Yap	Micronesia, Federated States of	FM (823)
Yemen		YE (653)
York, Duke of - Islands	Papua New Guinea	PG (801)
Yugoslav, Former - Republic of Macedonia	Macedonia, Former Yugoslav Republic	MK (096)

Z

Zaire	Congo, Democratic Republic of	CD (322)
Zambia		ZM (378)
Zanzibar, Island	Tanzania, United Republic of	TZ (352)
Zealand, Island	Denmark	DK (008)
Zemlya, Novaya	Russian Federation	RU (075)
Zemlya, Zevernya	Russian Federation	RU (075)
Zevernya Zemlya	Russian Federation	RU (075)
Zimbabwe		ZW (382)